

Gauge/gravity duality and meta-stable dynamical supersymmetry breaking

This article has been downloaded from IOPscience. Please scroll down to see the full text article.

JHEP01(2007)083

(<http://iopscience.iop.org/1126-6708/2007/01/083>)

View [the table of contents for this issue](#), or go to the [journal homepage](#) for more

Download details:

IP Address: 147.122.54.45

The article was downloaded on 15/11/2011 at 14:49

Please note that [terms and conditions apply](#).

Gauge/gravity duality and meta-stable dynamical supersymmetry breaking

Riccardo Argurio

*Physique Théorique et Mathématique and International Solvay Institutes
Université Libre de Bruxelles, C.P. 231, 1050 Bruxelles, Belgium
E-mail: rargurio@ulb.ac.be*

Matteo Bertolini

*SISSA/ISAS and INFN - Sezione di Trieste
Via Beirut 2; I 34014 Trieste, Italy
E-mail: bertmat@sissa.it*

Sebastián Franco

*Joseph Henry Laboratories, Princeton University
Princeton, NJ 08544, U.S.A.
E-mail: sfranco@feynman.princeton.edu*

Shamit Kachru

*Department of Physics and SLAC, Stanford University
Stanford, CA 94305 U.S.A., and
Kavli Institute for Theoretical Physics, University of California
Santa Barbara, CA 93106 U.S.A.
E-mail: skachru@stanford.edu*

ABSTRACT: We engineer a class of quiver gauge theories with several interesting features by studying D-branes at a simple Calabi-Yau singularity. At weak 't Hooft coupling we argue using field theory techniques that these theories admit both supersymmetric vacua and meta-stable non-supersymmetric vacua, though the arguments indicating the existence of the supersymmetry breaking states are not decisive. At strong 't Hooft coupling we find simple candidate gravity dual descriptions for both sets of vacua.

KEYWORDS: Supersymmetry Breaking, Gauge-gravity correspondence, Brane Dynamics in Gauge Theories.

Contents

1. Introduction	1
2. The theory	4
2.1 Masses from quantum moduli spaces	4
2.2 A \mathbb{Z}_2 orbifold of the conifold	6
2.3 Fractional branes	8
3. The duality cascade	9
3.1 The last cascade step	11
4. The meta-stable non-supersymmetric vacuum	13
4.1 Meta-stable vacuum in $N_f = N_c$ SQCD	14
4.2 Meta-stable vacuum in the \mathbb{Z}_2 orbifold of the conifold	16
5. Gravity dual	18
5.1 Effective superpotential and basic properties of the geometry	18
5.2 Couplings and scales	22
5.3 Supersymmetric vacua	22
5.4 Non-supersymmetric vacuum	23
5.5 Comments on the full solution	24
6. Conclusions	25
A. Geometry of the moduli space	28
B. Toric geometry, (p, q) webs and complex deformations	30
C. Type IIA description	32

1. Introduction

Quantum field theories which exhibit dynamical breaking of supersymmetry (DSB) may be relevant in the description of Nature at the electroweak scale [1]. While theories which accomplish DSB were found already in the early 1980s by Affleck, Dine and Seiberg (for a review of early work, see [2]), the subject has retained much of its interest over the past 25 years. For instance, in the earliest examples, the supersymmetry breaking vacua were global minima in chiral gauge theories. However, it was realized that by relaxing both of these criteria, one might obtain simpler examples [3] which could yield less contrived realistic models

of gauge mediation [4]. This insight was further developed in many papers [5], with perhaps the simplest idea that can yield complete models appearing very recently in [6]. Meta-stable supersymmetry breaking has also played a crucial rôle in many recent constructions of string vacua [7, 8], which quite plausibly realize the idea of a “discretuum” proposed in [9].

In the past decade, two new tools — Seiberg duality [10] and gauge/gravity duality [11] — have significantly improved our ability to analyze the dynamics of strongly coupled supersymmetric gauge theories. Since DSB is a strong-coupling phenomenon in many instances, these new tools should be exploited to improve our understanding of theories that exhibit DSB.

Gauge/gravity duality has already been applied in several different examples to illuminate the physics of supersymmetry breaking [12–16]. In one of these instances, the 3d gauge theory analyzed in [12], the direct field theory analysis [17] and the gravity analysis were seen to agree. In some other examples, such as those investigated in [14–16], the dual gauge theory does not admit any stable vacuum [15, 18, 19]. This is quite plausibly true in the large ’t Hooft coupling gravity dual as well, though compactifications of the scenario may fix this problem [20], through the generation of baryonic couplings which were shown to lead to stable non-supersymmetric vacua in some cases [21]. In [22], it was shown that these theories exhibit meta-stable non-supersymmetric vacua when massive flavors are added by means of D7-branes.

The examples of [13] (KPV) will be more relevant to our story. That work builds directly on the beautiful paper of Klebanov and Strassler [23], where a smooth gravity dual was found for the cascading $SU(N + M) \times SU(N)$ gauge theory of branes and fractional branes at the conifold. At the end of the cascade (for N a multiple of M) one finds a deformed conifold geometry with a large sphere of radius $\sqrt{g_s M}$, and M units of RR three-form flux piercing the sphere. It was proposed in [13] that by adding $p \ll M$ anti-D3 brane probes to this system, one could obtain non-supersymmetric states in the $SU(N + M - p) \times SU(N - p)$ supersymmetric gauge theory realized by branes at the conifold. Because the anti-D3 branes are attracted to the warped tip of the geometry, the supersymmetry breaking states have exponentially small vacuum energy. In addition, they are connected by finite energy bubbles of false vacuum decay, to the supersymmetric vacua of the $SU(N + M - p) \times SU(N - p)$ theory [13]. This, together with the fact that the boundary conditions at infinity in the gravity dual are the *same* for the supersymmetric and non-supersymmetric states (in contrast to the situation described in [24]), indicates that these are best thought of as dynamical supersymmetry breaking states in the $SU(N + M - p) \times SU(N - p)$ gauge theory at large ’t Hooft coupling. These states have played an important role in the KKLT construction [8], and in some models of inflation in string theory [25, 26]. More importantly for our purpose, it is obvious that the same analysis would yield meta-stable KPV-like states in many other confining gauge theories with smooth gravity duals.

In an a priori un-related development, it was recently found in the elegant paper of Intriligator, Seiberg and Shih [27] (ISS) that even the simplest non-chiral gauge theories can exhibit meta-stable vacua with DSB. A straightforward application of Seiberg duality to supersymmetric $SU(N_c)$ QCD with N_f slightly massive quark flavors of mass $m \ll \Lambda_{\text{QCD}}$, in the range $N_c + 1 \leq N_f < \frac{3}{2}N_c$, yields a dual magnetic theory which breaks supersymmetry

at tree-level.¹ The supersymmetry breaking vacuum is a miracle from the perspective of the electric description, occurring in the strong-coupling regime of small field VEVs where only the Seiberg dual description allows one to analyze the dynamics. And again, as will be important for us, the analysis of the original paper can be extended to provide many other examples.²

On closer inspection, there are several qualitative similarities between the KPV states (which were found using gauge/gravity duality) and the ISS states (which were found using Seiberg duality). In both examples, the supersymmetry breaking state is related to the existence of a baryonic branch; in both examples, it is a meta-stable state in a non-chiral gauge theory; and in both examples, there is an intricate moduli space of Goldstone modes (geometrized in the KPV case as the translation modes of the anti-D3s at the end of the Klebanov-Strassler throat). It is natural to wonder — is there some direct relation between these two classes of meta-stable states?³

In this paper, we propose that at least in some cases, the answer is *yes*. We analyze the gauge theory on D-branes at a certain simple singularity (obtained from a \mathbb{Z}_2 quotient of the conifold). We find that this non-chiral gauge theory admits both supersymmetric and supersymmetry breaking vacua — the non-supersymmetric vacua being found by a simple generalization of ISS. At large 't Hooft coupling, our system has a simple dual gravitational description, along the lines of [23]. We analyze the dual geometry, and propose natural candidates for the gravity description of both sets of vacua — with the non-supersymmetric vacua arising from a simple generalization of KPV. Our result suggests that there may be a general connection between the classes of states that are unveiled using the two techniques. Of course, this is example dependent: there is no firm argument that meta-stable states which are present at large 't Hooft coupling continue smoothly back to weak gauge coupling, or vice versa, in general. For this reason, it is not clear that the states of the original ISS model should have a simple gravity dual (or, that the states of the original KPV model, should have a simple weak-coupling description).

The organization of our paper is as follows. In §2, we describe the gauge theory that we will analyze, and a possible brane configuration in string theory that gives rise to it. In §3, we will describe a duality cascade (similar to the one in [23]) which will serve as a possible field theory UV-completion of our model; the gauge theory we will focus on arises at the end of the cascade. In §4, we argue, using field theory techniques, that our gauge theory admits meta-stable states that dynamically break supersymmetry, in addition to various supersymmetric vacua. In §5, we provide a description of candidate gravity duals for both the supersymmetric and supersymmetry breaking vacua. We conclude with a discussion of possible directions for further research and open questions in §6. We have relegated a detailed discussion of the geometry of the moduli space, complex deformations from toric geometry and a (T-dual) IIA brane system, to the appendices.

¹In [27], it has been suggested that a meta-stable, supersymmetry breaking vacuum also exists for $N_f = N_c$. We discuss the difficulties in the analysis of this case in §4.

²Some references which are in some respect relevant to our work are [28–31].

³This question has been raised by the present authors, H. Ooguri, N. Seiberg, H. Verlinde and many others.

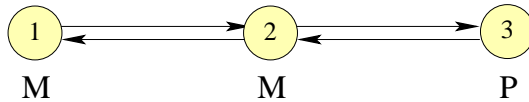

Figure 1: Sub-quiver that dynamically generates masses for the flavors of the third node.

2. The theory

In this section we present our model. We first present a prototype model that has some of the properties we are interested in finding. More precisely, this model exhibits ISS-like meta-stable vacua in a gauge theory where the very small flavor masses are not put in by hand, but instead are generated dynamically. Then, in order to illustrate our ideas, we provide a concrete and simple D-brane/string background which will serve as our privileged toy model in the rest of the paper. It should be kept in mind, however, that our proposal has a wide range of applicability and in principle many different string constructions could lead to this kind of dynamics.

2.1 Masses from quantum moduli spaces

A key ingredient in the construction of ISS-like models with non-supersymmetric meta-stable vacua is the existence of massive flavors. Since we do not want to introduce external masses, the only remaining option is to generate them dynamically by giving VEVs to fields participating in a cubic (or higher) vertex in the superpotential. Moreover, if we want to forbid those VEVs from relaxing to zero (which they may wish to do dynamically, since the vacuum energy of the would-be non-supersymmetric vacua is proportional to the quark masses), we have to impose at least one constraint on them. The most natural such constraint is the one describing the quantum deformed moduli space of $N_f = N_c$ SQCD [32].⁴ Hence, we are naturally led to a model of a quiver gauge theory which features at least one node in this regime.

Before presenting all the details in later sections, we briefly review here the simple mechanism that we want to propose in order to generate such masses dynamically. Let us consider the quiver diagram shown in figure 1 with a tree level superpotential involving at least the quartic interaction

$$W = \dots + X_{21}X_{12}X_{23}X_{32} + \dots \quad (2.1)$$

where here and henceforth, traces on gauge indices are understood.

Let us remind the reader that a quiver diagram is just a convenient pictorial way to encode the matter content of certain gauge theories. Every node in the quiver represents a gauge group (in this paper we will focus on $SU(N_i)$ gauge groups). An arrow connecting two nodes represents a chiral multiplet transforming in the fundamental representation of the node at its tail and the anti-fundamental representation of the node at its head.

Let us first suppose that the dynamical scales of the three gauge groups are $\Lambda_1 \gg \Lambda_3 \gg \Lambda_2$. The strong dynamics of node 1 is described in terms of mesons $\mathcal{M}^{i_2, j_2} = X_{21}^{i_2, i_1} X_{21}^{i_1, j_2}$

⁴Indeed, the quantum deformation was used for different but similar purposes in [3].

and baryons $\mathcal{B} = [X_{12}]^M$ and $\tilde{\mathcal{B}} = [X_{21}]^M$. The meson \mathcal{M} transforms in the adjoint representation of node 2. The tree level superpotential (2.1) becomes

$$W = \dots + \mathcal{M}X_{23}X_{32} + \dots \quad (2.2)$$

Node 1 has M colors and M flavors and hence leads to a quantum modified moduli space, corresponding to

$$\det_{i_2, j_2} \mathcal{M} - \mathcal{B}\tilde{\mathcal{B}} = \Lambda_1^{2M} \quad (2.3)$$

On the mesonic branch, $\langle \mathcal{B} \rangle = \langle \tilde{\mathcal{B}} \rangle = 0$ and $\det_{i_2, j_2} \langle \mathcal{M} \rangle = \Lambda_1^{2M}$. The gauge group is higgsed down to $SU(P) \times U(1)^{M-1}$, with the abelian factors coming from the adjoint higgsing of the second node.

From the point of view of node 3, X_{23} and X_{32} give rise to M flavors with i_2 becoming a flavor index. When the expectation value of \mathcal{M} is plugged into (2.2), it gives rise to non-zero masses for these flavors. The theory becomes precisely $SU(P)$ SQCD with M massive flavors. The masses are constrained by (2.3) but are dynamical quantities. In order to follow the argument of ISS, we would then perform a Seiberg duality on node 3, which is the one responsible for DSB.

The $\Lambda_1 \gg \Lambda_3 \gg \Lambda_2$ regime we have just discussed is the simplest to study, since as we lower the energy scale we first generate the masses for the flavors of node 3. However, in order for the analysis of ISS to be valid, flavor masses should be much smaller than the dynamical scale Λ_3 .

Since the masses are dictated by Λ_1 , it is more natural to achieve a small mass to Λ_3 ratio for $\Lambda_3 \gg \Lambda_1 \gg \Lambda_2$. If $P < M$, we begin by dualizing node 3. If $P + 1 \leq M < \frac{3}{2}P$, node 3 is IR free in the dual theory. In the magnetic theory, there are mesons $\mathcal{N}^{i_2, j_2} = X_{23}^{i_2, i_3} X_{32}^{i_3, j_2}$ and “dual quarks” Y_{32} and Y_{23} . The superpotential becomes

$$W_{\text{mag}} = \dots + X_{21}X_{12} \mathcal{N} + \mathcal{N} Y_{23}Y_{32} + \dots \quad (2.4)$$

where the first terms comes from (2.2) and the second one is the usual cubic coupling between Seiberg mesons and dual quarks. At the Λ_1 scale, node 1 develops a quantum moduli space as in (2.3). Going to the mesonic branch, the superpotential becomes

$$W_{\text{mag}} = \dots + \langle \mathcal{M} \rangle \mathcal{N} + \mathcal{N} Y_{23}Y_{32} + \dots \quad (2.5)$$

The rank condition of ISS [27] arises from the F-term of \mathcal{N} .⁵

We thus conclude that our model potentially admits meta-stable nonsupersymmetric vacua for both $\Lambda_1 \gg \Lambda_3 \gg \Lambda_2$ and $\Lambda_3 \gg \Lambda_1 \gg \Lambda_2$. In fact, we have shown that going on the quantum deformed mesonic branch of node 1, and performing the Seiberg duality on node 3, are commuting operations. Hence we do not have to assume an a priori hierarchy between the scales Λ_1 and Λ_3 . A more detailed examination in §4 will show that the only

⁵The rank condition corresponds to the inability to have all $F_{\mathcal{N}^{i_2, j_2}} = 0$ because the rank of node 3 in the magnetic theory (which determines the maximum possible rank of $Y_{23}Y_{32}$) is $(M - P)$, smaller than the dimension of \mathcal{M} .

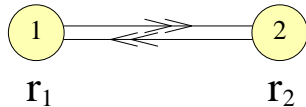

Figure 2: Quiver diagram for the conifold with $SU(r_1) \times SU(r_2)$ gauge group.

really plausible case is when $M = P$.⁶ There, it is natural to assume strong dynamics at both nodes 1 and 3 simultaneously. In §5.1 we argue that essentially any hierarchy between Λ_1 and Λ_3 is attainable in a string theory realization of this model.

The gauge theory described above can be viewed as a sub-sector embedded in a larger quiver, with possibly more gauge groups, fields (even charged under node 3) and superpotential interactions.

2.2 A \mathbb{Z}_2 orbifold of the conifold

In this section we present a theory that contains the sub-quiver discussed in §2.1 and hence has the appropriate non-chiral matter and quartic interactions to generate dynamical masses by quantum deformation of the moduli space. In addition, this model has a concrete string theory realization in terms of D-branes probing a singularity.

The model we consider is a non-chiral \mathbb{Z}_2 orbifold of the conifold (see e.g. [33]). It follows from the conifold gauge theory by the standard orbifolding procedure. Figure 2 shows the conifold quiver for arbitrary ranks r_1 and r_2 . The corresponding superpotential is

$$W = h\epsilon^{ij}\epsilon^{kl}A_iB_kA_jB_l. \quad (2.6)$$

The conifold may be described by the following equation in four complex variables

$$xy = zw. \quad (2.7)$$

The gauge invariant variables are given in terms of the chiral bifundamental fields by

$$x \sim A_1B_1 \quad y \sim A_2B_2 \quad z \sim A_1B_2 \quad w \sim A_2B_1. \quad (2.8)$$

The \mathbb{Z}_2 orbifold group has a single generator θ , whose geometric action corresponds to quotienting by the following identifications⁷

$$\begin{aligned} x &\rightarrow x & y &\rightarrow y \\ z &\rightarrow -z & w &\rightarrow -w. \end{aligned} \quad (2.9)$$

We can define new variables that are invariant under the orbifold group. From the action in (2.9), they are $x' = x$, $y' = y$, $z' = z^2$ and $w' = w^2$. It is now straightforward to see that the orbifolded geometry is given by the following equation

$$x'^2y'^2 = w'z'. \quad (2.10)$$

⁶The argument for the existence of a meta-stable vacuum when $P = M$ is more subtle, see §4.

⁷Other quotients are possible. For example $x \rightarrow -x$, $y \rightarrow -y$, $z \rightarrow -z$ and $w \rightarrow -w$ gives rise to the also well studied cone over the zeroth Hirzebruch surface F_0 .

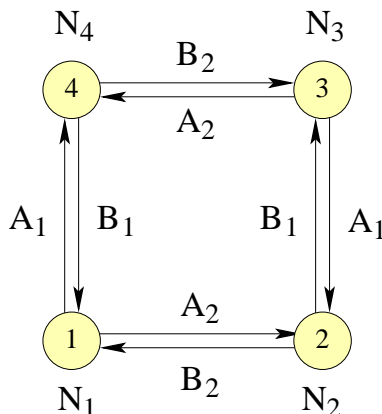

Figure 3: Quiver diagram for the \mathbb{Z}_2 orbifold of the conifold under consideration, for arbitrary numbers of fractional and regular D3-branes. We have labeled bifundamentals according to the parent field.

We re-derive this equation from the field theory in appendix A. The resulting geometry turns out to be toric. A convenient way to describe toric geometries is via toric diagrams and (p, q) webs, this being a useful way for visualizing the geometric structure of the singularity, the possible complex structure deformations, the number (and type) of allowed fractional branes, etc. Appendix B provides a brief review of toric geometry and the applications of (p, q) webs together with a more detailed analysis of the case under investigation.

Let us now construct the orbifolded gauge theory. We start from the conifold theory with $SU(r_1) \times SU(r_2)$ gauge group. The coordinates are related to the chiral fields as in (2.8). It follows that the geometric action of the orbifold group generator θ given by (2.9) can be implemented by

$$\begin{aligned} A_1 &\rightarrow -A_1 & A_2 &\rightarrow A_2 \\ B_1 &\rightarrow -B_1 & B_2 &\rightarrow B_2 . \end{aligned} \tag{2.11}$$

In addition, we have to specify the action of θ on the Chan-Paton factors of the two gauge groups. We take it to be

$$\begin{aligned} \gamma_{\theta,1} &= \text{diag}(\mathbf{1}_{N_1}, -\mathbf{1}_{N_3}) \\ \gamma_{\theta,2} &= \text{diag}(\mathbf{1}_{N_2}, -\mathbf{1}_{N_4}) \end{aligned} \tag{2.12}$$

where $N_1 + N_3 = r_1$ and $N_2 + N_4 = r_2$. The resulting gauge group is $\prod_{i=1}^4 SU(N_i)$. Both the conifold gauge theory and the orbifold we are studying are completely non-chiral. Hence there are no constraints on the ranks of the various gauge groups coming from anomaly cancellation — they are completely arbitrary. Combining the geometric and Chan-Paton actions, we conclude that the original fields give rise to the following chiral multiplets

$$\begin{aligned} A_1 &\rightarrow X_{14}, X_{32} & A_2 &\rightarrow X_{12}, X_{34} \\ B_1 &\rightarrow X_{41}, X_{23} & B_2 &\rightarrow X_{21}, X_{43} . \end{aligned} \tag{2.13}$$

The resulting quiver is shown in figure 3, in which we have indicated the parent fields.

The superpotential follows from projecting (2.6) and is given by

$$W = h(X_{14}X_{41}X_{12}X_{21} + X_{32}X_{23}X_{34}X_{43} - X_{14}X_{43}X_{34}X_{41} - X_{32}X_{21}X_{12}X_{23}) . \quad (2.14)$$

2.3 Fractional branes

This theory has three types of fractional branes. They correspond to different ways in which D5-branes can be wrapped over 2-cycles collapsed at the tip of the singularity. At the level of the gauge theory, this corresponds to the already noted fact that anomaly freedom does not constrain the ranks of the four gauge groups. A convenient basis of fractional branes is given by the rank vectors $(1, 1, 0, 0)$, $(0, 0, 1, 0)$ and $(1, 0, 0, 0)$. In this language, $(1, 1, 1, 1)$ represents a regular D3-brane.

In [15], a classification of fractional branes based on the IR behavior they trigger was introduced. It turns out there are three different classes of fractional branes:

- *$\mathcal{N} = 2$ fractional branes:* the quiver gauge theory on them (in the absence of regular D3-branes) has closed oriented loops (gauge invariant operators) that do not appear in the superpotential. Hence, these fractional branes have flat directions parametrized by the expectation values of these mesonic operators. From a geometric point of view, these fractional branes arise when the singularities are not isolated, but have curves of $\mathbb{C}^2/\mathbb{Z}_N$ singularities passing through them. The IR dynamics of the gauge theories (instantons and Seiberg-Witten points) map to an enhancement mechanism in a gravity dual description [34].
- *Deformation fractional branes:* the quiver on these branes is either a set of decoupled nodes, or nodes with closed loops that appear in the superpotential. The ranks of all gauge factors are equal. Geometrically, these fractional branes are associated with a possible complex deformation of the singularity. In the gauge theory, the gauge groups which are involved undergo confinement. This is translated to a complex structure deformation leading to finite size 3-cycles in the gravity dual.
- *DSB fractional branes:* these are fractional branes of any other kind, hence they provide the generic case. In this case, the non-trivial gauge factors have unequal ranks. Geometrically, they are associated with geometries for which the corresponding complex deformation is obstructed. The gauge theory dynamics corresponds to the appearance of an Affleck-Dine-Seiberg (ADS) superpotential [35] that removes the supersymmetric vacuum [14–16]. Furthermore (as first discussed in [15] and later studied in detail in [18, 19]) the gauge theory has a runaway behavior towards infinity parametrized by di-baryonic operators.

It is important to keep in mind that combining fractional branes in one or more of these classes can lead to fractional branes of another kind. In the example under study, the $(0, 0, 1, 0)$ and $(1, 0, 0, 0)$ branes are deformation fractional branes, while $(1, 1, 0, 0)$ is an $\mathcal{N} = 2$ fractional brane.

In order to make contact with our discussion in §2.1, we will focus on the quiver with ranks $(M, M, P, 0)$. It can be engineered by using M $(1, 1, 0, 0)$ and P $(0, 0, 1, 0)$ fractional

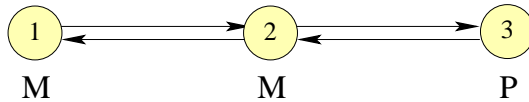

Figure 4: Quiver diagram for $(M, M, P, 0)$ ranks.

branes. The resulting quiver is shown in figure 4. The surviving superpotential is given by

$$W = hX_{32}X_{21}X_{12}X_{23} \quad (2.15)$$

where, for later convenience, we have changed the coupling h by an overall sign with respect to (2.14).

This is precisely the theory discussed in §2.1. In the next section we explain in detail how this theory arises at the IR end of a duality cascade. Its vacuum structure will be analyzed in §4.

3. The duality cascade

It is always the case that supergravity solutions describing the geometry generated by sets of fractional branes have (logarithmically) running fluxes. The cut-off one is forced to introduce in order to regulate the logarithms automatically brings regular branes into the story, from which the fractional branes cannot then be disentangled, if one aims for a weakly curved supergravity description. The same holds for the quiver in figure 4 which should be thought of as part of a more general theory, involving regular branes, too.

In general, the dynamics of stacks of fractional and regular branes gets a natural interpretation in terms of a duality cascade (for $\mathcal{N} = 1$ gauge/gravity dualities). This is well understood for the case of the conifold [36, 23, 37]. However, when departing from this well known example and focusing on more involved theories, it is not straightforward to visualize a specific pattern [38, 39]. Here, we will provide one. The discussion is somewhat involved, and a reader who is interested purely in the dynamics of the quiver in figure 4 can skip this section on a first reading.

In general, the physics of a cascade is obtained when one perturbs a fixed point of some SCFT, generated by N regular D3-branes at a singularity, with some (smaller) number of fractional D3-branes. This brings the theory out of the fixed point and triggers a non-trivial RG-flow. What happens, in a quite model-independent way, is that the number of regular branes effectively diminishes along the flow and the IR dynamics of the theory is determined by fractional branes only. Therefore, the natural guess for the UV theory generating via RG-flow the dynamics depicted in figure 4 in the IR, should be one described by N regular branes, $M \mathcal{N} = 2$ fractional branes and P deformation fractional branes corresponding to the quiver in figure 5, with in addition the tree-level superpotential

$$W = X_{14}X_{41}X_{12}X_{21} + X_{32}X_{23}X_{34}X_{43} - X_{14}X_{43}X_{34}X_{41} - X_{32}X_{21}X_{12}X_{23} \quad (3.1)$$

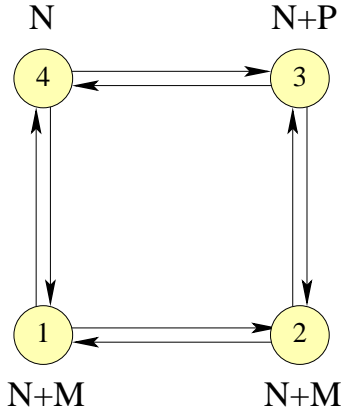

Figure 5: Quiver generated by N regular branes, M $(1, 1, 0, 0)$ and P $(0, 0, 1, 0)$ fractional branes.

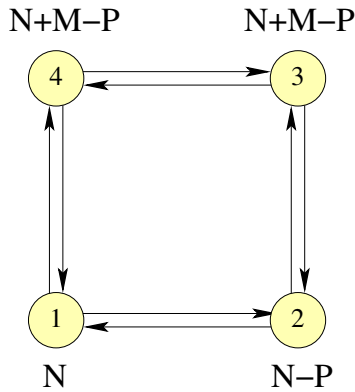

Figure 6: The theory after one full cascade step.

which is the same as (2.14) up to an overall constant.⁸ In what follows, we show that this is a correct guess.

For a cascade to actually occur, the theory should be self-similar, that is after a certain number of Seiberg dualities it should return to itself (including the superpotential), but with a reduced number N of regular branes. This model, unlike its cousin the conifold, needs more than one Seiberg duality to display its self-similar structure. In fact, a possible pattern is via four subsequent duality steps, where these are taken on the gauge groups of nodes 1, 3, 2 and 4, respectively. With properly chosen initial conditions one can show that the theory one obtains after this pattern of Seiberg dualities (a *single* cascade step) is the one depicted in the quiver in figure 6 with superpotential (3.1).⁹

⁸In this superpotential and subsequent ones in this section we omit coupling constants. At every Seiberg duality dynamical scales must be matched and mesonic fields are normalized in order to give them canonical dimensions according to standard rules. For the sake of simplicity, we choose the simplest approach of reinserting the superpotential coupling in the final result (3.9).

⁹In the process a number of non-trivial intermediate steps occur, to make the theory self-similar. In particular, there are extra (adjoint) fields generated at each duality step, together with the corresponding cubic superpotential terms. Every two Seiberg duality steps, the adjoint fields pair up in mass terms and can be integrated out consistently.

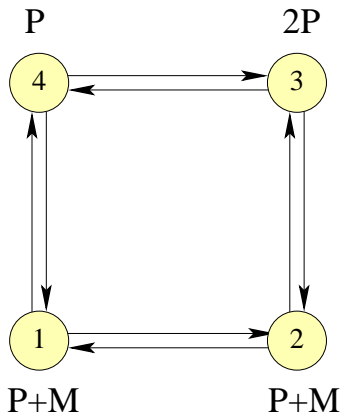

Figure 7: The theory at the next-to-last step of the cascade, $N = P$.

This is the same as the original theory, after taking $N \rightarrow N - P$ and re-labeling the indices as $1 \leftrightarrow 3$, $2 \leftrightarrow 4$. This proves the self-similar structure of the theory and the existence of the cascade. Notice that only deformation branes enter the cascade: the diminishing of the number of regular branes along the cascade is only affected by the P deformation branes. It may be worth noticing, at this point, that the several (four in the present case) Seiberg dualities needed to recover the self-similarity of the theory could be thought of as if they were done simultaneously. What is more physical, and indeed is usually captured by the gravity dual through the running of the B_2 (and consequently F_5) flux, are the *cascade* steps.

Suppose now $N = kP$. Naively, one would say that after k cascade steps of the type discussed above, N gets reduced to 0 yielding the theory we are looking for, namely the quiver in figure 4. This turns out to be correct. However, one should remember that strictly speaking the final step of a cascade is not described by a Seiberg duality since generically, at such energy scales, at least one gauge group ends up having $N_f = N_c$ and the moduli space is deformed at the quantum level. As in the well-studied case of the conifold, in our case one can show that the strongly coupled gauge group confines and along the baryonic branch one indeed ends up with the theory in figure 4 (while, as in the conifold case, the mesonic branch has instead P freely-moving regular branes in the background [40]).

3.1 The last cascade step

Let us treat the last cascade step more carefully (this is done along the lines of [16]). After $k - 1$ steps one gets effectively $N = P$ with the corresponding quiver reported in figure 7.

Apparently, this looks different from known examples in the literature since, here, for any node $N_f > N_c$ and the moduli space is *not* deformed at the quantum level. However, after taking the first two Seiberg dualities, on nodes 1 and 3, respectively, one gets

$$N'_1 = 2P + M - P - M = P \quad \text{and} \quad N'_3 = 2P + M - 2P = M \quad (3.2)$$

with corresponding quiver as in figure 8 and superpotential (3.1). As already noticed, the adjoint fields generated by Seiberg duality are massive and can be integrated out, together

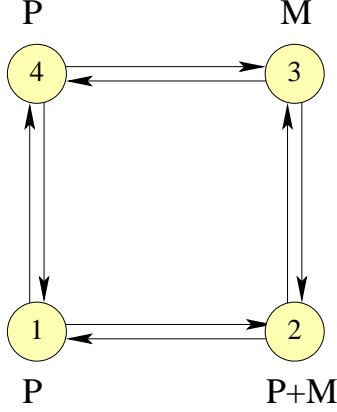

Figure 8: The intermediate step.

with their superpotential interaction terms. Here the process stops since node 2 now has $N_c = N_f = P + M$ and the moduli space gets deformed at the quantum level. Let us then focus on the dynamics of node 2. The quantum constraint reads

$$\det \mathcal{M} - \mathcal{B}\tilde{\mathcal{B}} = \Lambda_2^{2(P+M)} . \quad (3.3)$$

The baryons can be written as

$$\mathcal{B} \sim (X_{32})^M (X_{12})^P , \quad \tilde{\mathcal{B}} \sim (X_{23})^M (X_{21})^P \quad (3.4)$$

where contraction with the Levi-Civita tensor is understood. The meson matrix can be written as

$$\mathcal{M} = \begin{pmatrix} X_{12}X_{21} & X_{12}X_{23} \\ X_{32}X_{21} & X_{32}X_{23} \end{pmatrix} \equiv \begin{pmatrix} \mathcal{M}_{11} & \mathcal{M}_{13} \\ \mathcal{M}_{31} & \mathcal{M}_{33} \end{pmatrix} . \quad (3.5)$$

The superpotential is given by

$$W = X_{14}X_{41}\mathcal{M}_{11} + \mathcal{M}_{33}X_{34}X_{43} - X_{14}X_{43}X_{34}X_{41} - \mathcal{M}_{31}\mathcal{M}_{13} + \lambda \left(\det \mathcal{M} - \mathcal{B}\tilde{\mathcal{B}} - \Lambda_2^{2(P+M)} \right) \quad (3.6)$$

where λ is a gauge invariant chiral field that acts as a Lagrange multiplier enforcing (3.3). Let us focus on the baryonic branch, $\det \mathcal{M} = \lambda = 0$, $\mathcal{B}\tilde{\mathcal{B}} = \Lambda_2^{2(P+M)}$. Looking at the superpotential (3.6) one sees both \mathcal{M}_{13} and \mathcal{M}_{31} are massive and can be integrated out. Node 2 confines and below the strong coupling scale Λ_2 the theory gets reduced to the quiver in figure 9, with superpotential

$$W = X_{14}X_{41}\mathcal{M}_{11} + \mathcal{M}_{33}X_{34}X_{43} - X_{14}X_{43}X_{34}X_{41} . \quad (3.7)$$

Now we can finally Seiberg dualize on node 4, which has $N_f = M + P > N_c = P$. After dualization its rank becomes M . There will be a meson matrix \mathcal{N} similar to (3.5) in terms of which the effective superpotential reads

$$W = \mathcal{N}_{11}\mathcal{M}_{11} + \mathcal{M}_{33}\mathcal{N}_{33} - \mathcal{N}_{13}\mathcal{N}_{31} - \mathcal{N}_{11}Y_{14}Y_{41} - \mathcal{N}_{33}Y_{34}Y_{43} + \mathcal{N}_{13}Y_{34}Y_{41} + \mathcal{N}_{31}Y_{14}Y_{43} \quad (3.8)$$

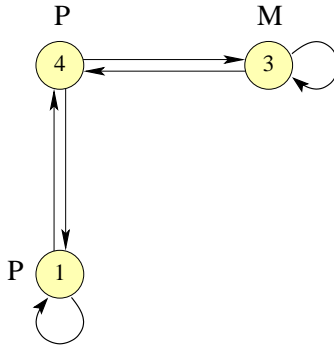

Figure 9: The theory below the Λ_2 scale.

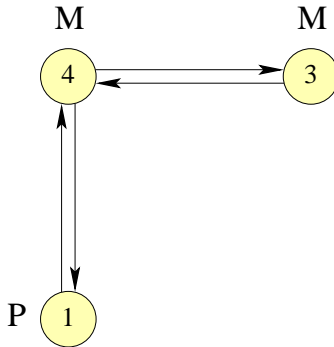

Figure 10: The theory at the bottom of the cascade.

where the Y_{ij} are the dual quarks. Now we can integrate out all the mesons getting the superpotential

$$W = h Y_{14} Y_{43} Y_{34} Y_{41} \quad (3.9)$$

where we have made the superpotential coupling explicit, calling it h as in the original theory for simplicity. The corresponding quiver is shown in figure 10.

This is nothing but the theory of figure 4 and superpotential (2.15), after a trivial re-labeling of letters ($Y \rightarrow X$) and indices ($3 \leftrightarrow 1, 4 \leftrightarrow 2$), as promised.

4. The meta-stable non-supersymmetric vacuum

The theory we want to analyze has a rich structure and, as we are going to show, admits both supersymmetric as well as (meta-stable) non-supersymmetric vacua. In this section we will be concerned with the latter and argue, in particular, that they actually arise only in the case where $P = M$.

Let us first consider our 3-node quiver in figure 4, with $P < M$. In this case, we have $N_f = M > P = N_c$. This is potentially interesting because we could in principle be in the range $N_c + 1 \leq N_f < \frac{3}{2} N_c$. In this case the theory has an IR free Seiberg dual description and the arguments of ISS in favor of meta-stability are conclusive.

On the baryonic branch of node 1, a standard analysis shows that one has then to perform a Seiberg duality on node 3, and integrate out two adjoints on node 2. We eventually

end up in a two node $SU(M) \times SU(M - P)$ quiver with vanishing tree level superpotential. What was formerly labeled node 2 develops an ADS runaway superpotential and there is no stable vacuum.

On the mesonic branch of node 1, we have the supersymmetric moduli space of the $\mathcal{N} = 2$ fractional branes. This is best seen assuming that the VEVs of the mesons \mathcal{M} give a mass to the flavors of node 3, and integrating the latter out. Hence at every point on the moduli space we have the P vacua of $SU(P)$ SYM.

As for the non supersymmetric states, following §2.1 and the analysis of [27], we would expect a meta-stable vacuum with vacuum energy

$$V_{\text{meta}} \sim |\Lambda_3|^2 \sum_{i=1}^P |hm_i|^2 \tag{4.1}$$

where m_1, \dots, m_P are the P eigenvalues of \mathcal{M} with smallest absolute values. Clearly, the constraint $\det \mathcal{M} = \Lambda_1^{2M}$ does not set a minimum value for them. What happens is that m_1, \dots, m_P relax to zero, while some of the other eigenvalues run away to infinity so that $\det \mathcal{M}$ remains constant. As a result, we conclude that there is no SUSY breaking ISS state for $P < M$.

We can also briefly ask what happens in the case $P > M$. The baryonic branch can be shown to have a runaway because the $SU(P)$ node has an ADS superpotential which drives the meson \mathcal{M} to infinity. The supersymmetric mesonic branch is exactly as above. The ISS-like meta-stable states are absent because $N_f < N_c$ for the $SU(P)$ gauge group.

We are thus left with only one potentially interesting case, namely $P = M$. We now show that there is indeed evidence, albeit weaker, for both supersymmetric and supersymmetry breaking states in this case.

4.1 Meta-stable vacuum in $N_f = N_c$ SQCD

We begin by reviewing how we can heuristically recover the meta-stable vacua conjectured to exist by Intriligator, Seiberg and Shih [27] in $N_f = N_c$ SQCD. We note that their conjecture for this case is based on somewhat weaker evidence than for the cases with $N_c + 1 \leq N_f < \frac{3}{2}N_c$.

Supposing that the quark chiral fields have a small mass m , the low energy effective superpotential for the mesons $\mathcal{M} = Q\tilde{Q}$ and the baryons is

$$W = \text{tr } m \mathcal{M} + \lambda(\det \mathcal{M} - \mathcal{B}\tilde{\mathcal{B}} - \Lambda^{2N_c}) . \tag{4.2}$$

The F-term conditions are

$$\det \mathcal{M} - \mathcal{B}\tilde{\mathcal{B}} = \Lambda^{2N_c}, \quad m + \lambda(\det \mathcal{M})\mathcal{M}^{-1} = 0, \quad \lambda\mathcal{B} = 0 = \lambda\tilde{\mathcal{B}} . \tag{4.3}$$

If we are to satisfy the equation involving m , we must have $\lambda \neq 0$. This implies that $\mathcal{B} = \tilde{\mathcal{B}} = 0$, which we usually refer to as being on the mesonic branch. Then the constraint $\det \mathcal{M} = \Lambda^{2N_c}$ eventually leads to a SUSY vacuum with mesonic VEVs

$$\mathcal{M} = m^{-1}(\det m)^{\frac{1}{N_c}} \Lambda^2 \sim \Lambda^2 . \tag{4.4}$$

We assume here and below that the masses are all of the same order. With this assumption, note that the mass dependence of the mesonic VEVs actually cancels.

Alternatively, if we want to give non zero VEVs to the baryons, $\mathcal{B}, \tilde{\mathcal{B}} \neq 0$, which is usually referred to as being on the baryonic branch, we must set $\lambda = 0$. The equation involving m can no longer be satisfied, and this gives rise to the non-vanishing F-terms contributing to the vacuum energy. Taking for convenience a mass matrix proportional to the identity, we would get

$$V_{\text{meta}} \sim N_c |m|^2 |\Lambda|^2 . \tag{4.5}$$

The factor of Λ comes from the proper normalization of the meson field \mathcal{M} (whose F-term is non-vanishing), under the assumption that we are at a smooth (though strongly coupled) point in the moduli space.

Note that though we have referred to mesonic and baryonic branches, they are not really disconnected.¹⁰ The only (N_c) SUSY vacua have fixed non zero VEVs for the mesons and vanishing VEVs for the baryons. Thus *any* state with different VEVs on the original quantum moduli space is a non SUSY state. Clearly most of those states are not meta-stable (they have tadpoles), and smoothly relax to the SUSY vacua. The argument by ISS, based on $m \ll \Lambda$ and the relation to the more controlled case of $N_f = N_c + 1$, is that far from the SUSY states, i.e. when the baryons have the largest allowed VEVs, the state is meta-stable. It can be shown that the tree-level potential has indeed an extremum there, with flat directions that are not lifted by loops of massive but light flavors. We should emphasize again that the $N_f = N_c$ case is the one in which the ISS arguments favoring the existence of a meta-stable vacuum are least explicit.

Meta-stability should of course eventually be verified by checking how the pseudo-moduli are lifted around that vacuum by higher order (in $1/\Lambda^2$) terms in the Kähler potential. Relevant considerations about the Kähler potential in a system very similar to the one discussed here and below can be found in [3], where arguments in favor of a local minimum are given. It would also be interesting to investigate the trajectories in field space connecting the meta-stable vacuum to the SUSY ones along which the potential barrier coming from the tree-level superpotential is minimum. The height and width of the potential barrier determine the lifetime of the meta-stable vacuum.

Here, we make one more comment about the lifting of pseudo-moduli that applies to compactifications of our solutions (along the lines of [41]). On the baryonic branch, there is a $U(1)_B$ symmetry which is spontaneously broken by the baryon VEV. In the decoupled theory, this $U(1)_B$ is a global symmetry, and its breaking gives rise to a Goldstone boson and its saxion partner (as discussed in, for instance, [42]). The saxion is a dangerous direction — its masslessness is not protected by a symmetry, and in any non-supersymmetric vacuum,

¹⁰We assume here that even on the non SUSY states, the constraint has to be applied. Indeed, the constraint is in fact a non dynamical F-term, hence it cannot be violated. It is a relation in the chiral ring which has no classical nor perturbative corrections in any state. The only way it could be evaded is by non-perturbative \bar{D} exact contributions which could be non vanishing in a non SUSY state. Though presumably most of these corrections can be excluded by further considerations, even if they are there, they will not change significantly the structure of the constraint, just shifting by a small amount the effective value of Λ^{2N_c} in the non SUSY state.

one can worry that it could become tachyonic. In *compactifications* of this kind of theory, there is one known computable contribution to the mass that acts in the direction of stabilizing the supersymmetry breaking vacuum.

String compactifications do not have continuous global symmetries. Instead, the $U(1)_B$ becomes a gauge symmetry. The baryon VEVs then give mass to the $U(1)$ gauge boson via the Higgs mechanism, and the would-be Goldstone multiplet is “eaten.” The relevant mass that is imparted is proportional to the product of the gauge coupling and the baryon VEVs, and following §6 of [42], this can be estimated as follows. If the hierarchy of scales generated by the cascade is $\sim e^{-\tau_{\max}}$, then the mass will be

$$M_{\text{saxion}} \sim \frac{g_s}{\sqrt{\tau_{\max}}} \Lambda . \tag{4.6}$$

Therefore, as long as one works in a compactification where this mass scale is larger than the other effects communicating the SUSY-breaking auxiliary field VEV to the saxion (which is not always true), the Higgs mechanism acts to help remove this possible source of instability. This remark is relevant to the Goldstone/saxion multiplets arising from the breaking of each $U(1)_B$ that occurs in our theory.

However, this argument is far from conclusive. There are also expected to be contributions to the mass arising from the strongly coupled dynamics. If for instance ϕ is the multiplet containing the saxion (as its real part), and \mathcal{M} is the multiplet that gets the SUSY-breaking F-term, terms of the form

$$\int d^4\theta \frac{c}{\Lambda^2} \mathcal{M}^\dagger \mathcal{M} (\phi + \phi^\dagger)^2 \tag{4.7}$$

should be expected to arise in the Kähler potential, with c some number which is a priori of $\mathcal{O}(1)$. Obviously depending on the sign of c this contribution can either help stabilize or try to de-stabilize the saxion; for the “wrong sign” of c , only moderately small $|c|$ can be overcome by the contribution (4.6). Here, we expect $F_{\mathcal{M}} \sim m\Lambda$, so for small quark masses, the contribution (4.6) can plausibly dominate.

Note that in the supersymmetry breaking states of [13], the saxion indeed gets stabilized around zero. This is most convincingly shown by computing the anti-D3 brane tension, which is minimum for vanishing saxion as shown in figure 6 of [40]. As we will review in §5, our set up is slightly different because we are no longer in the probe approximation for the anti-D3-branes.

4.2 Meta-stable vacuum in the \mathbb{Z}_2 orbifold of the conifold

We now come back to the theory at the bottom of the cascade for the \mathbb{Z}_2 orbifold of the conifold, figure 4 and superpotential (2.15). We concentrate here on the case where $P = M$.

We consider that both nodes 1 and 3 have confining dynamics. Indeed, they should be the ones reaching strong coupling first. We can actually assume that $\Lambda_1, \Lambda_3 \gg \Lambda_2$. The relative hierarchy between Λ_1 and Λ_3 is not fixed for the moment. We thus have the following effective fields

$$\mathcal{M} = X_{21}X_{12}, \quad \mathcal{N} = X_{23}X_{32} \tag{4.8}$$

$$\mathcal{B} = (X_{12})^P, \quad \tilde{\mathcal{B}} = (X_{21})^P, \quad \mathcal{C} = (X_{32})^P, \quad \tilde{\mathcal{C}} = (X_{23})^P . \tag{4.9}$$

The effective superpotential, which includes the tree level piece (2.15) (note that cyclic permutations among fundamental fields are allowed in the superpotential, since a trace on gauge indices is always understood) and the quantum constraints for nodes 1 and 3, read

$$W = h\mathcal{M}\mathcal{N} + \lambda_1(\det \mathcal{M} - \mathcal{B}\tilde{\mathcal{B}} - \Lambda_1^{2P}) + \lambda_3(\det \mathcal{N} - \mathcal{C}\tilde{\mathcal{C}} - \Lambda_3^{2P}) . \quad (4.10)$$

Treating node 2 as classical, we can integrate out all the effective fields. The F-terms that have to vanish in a supersymmetric vacuum are

$$\det \mathcal{M} - \mathcal{B}\tilde{\mathcal{B}} = \Lambda_1^{2P} , \quad \det \mathcal{N} - \mathcal{C}\tilde{\mathcal{C}} = \Lambda_3^{2P} \quad (4.11)$$

$$h\mathcal{N} + \lambda_1(\det \mathcal{M})\mathcal{M}^{-1} = 0 , \quad h\mathcal{M} + \lambda_3(\det \mathcal{N})\mathcal{N}^{-1} = 0 \quad (4.12)$$

$$\lambda_1\mathcal{B} = 0 = \lambda_1\tilde{\mathcal{B}} , \quad \lambda_3\mathcal{C} = 0 = \lambda_3\tilde{\mathcal{C}} . \quad (4.13)$$

First of all, we can go on the baryonic branch for both nodes 1 and 3. This implies having $\lambda_1 = 0 = \lambda_3$, which in turn sets to zero the VEVs of the two mesons \mathcal{M} and \mathcal{N} . Hence we have two decoupled one-dimensional baryonic branches, and eventually a confining $SU(P)$ SYM at node 2. This should correspond on the gravity side to a single deformation.

A second choice is to be on the mesonic branch at both nodes 1 and 3. Then we need $\lambda_1, \lambda_3 \neq 0$ and hence we must set all baryonic VEVs to zero. The mesons are both of maximal rank due to the quantum constraints, and are eventually related by $\mathcal{N} \sim \Lambda_1^2 \Lambda_3^2 \mathcal{M}^{-1}$. Hence we have only one mesonic moduli space. Moreover, node 2 is higgsed to $U(1)^{P-1}$ and does not reach strong coupling. The gravity dual interpretation of the above vacuum is that the $\mathcal{N} = 2$ fractional branes are exploring their moduli space.

We could now consider having one node on the baryonic branch and the other on the mesonic branch. However, putting, say, node 1 on the mesonic branch would require $\mathcal{M} \neq 0$ while putting node 3 on the baryonic branch implies $\lambda_3 = 0$, which is not consistent with the vanishing of the F-term $\partial W / \partial \mathcal{N} = 0$. If all the other F-terms are vanishing, we would have a vacuum energy

$$V = |\Lambda_3|^2 \sum_{i=1}^P |hm_i|^2 \quad (4.14)$$

where $m_i, i = 1, \dots, P$, are the eigenvalues of \mathcal{M} and we have assumed that $K^{\mathcal{N}\tilde{\mathcal{N}}} \sim |\Lambda_3|^2$. The F-term on the left of (4.11) constrains the eigenvalues of \mathcal{M} according to $\det \mathcal{M} = \prod_{i=1}^P m_i = \Lambda_1^{2P}$. Minimizing (4.14) subject to this constraint, we conclude that the m_i are classically stabilized at $m_i = \Lambda_1^2$ for all i . The vacuum energy at the meta-stable vacuum then becomes

$$V_{\text{meta}} = P|h\Lambda_1^2|^2|\Lambda_3|^2 . \quad (4.15)$$

We could do the reasoning in two steps. For example, if $\Lambda_1 \gg \Lambda_3$, we can first integrate out the dynamics of node 1. If it is on the mesonic branch, the F-conditions on the left column tell us that $h\mathcal{M}\mathcal{N} = Ph\Lambda_1^2(\det \mathcal{N})^{1/P}$. Hence we arrive at the superpotential

$$W = Ph\Lambda_1^2(\det \mathcal{N})^{1/P} + \lambda_3(\det \mathcal{N} - \mathcal{C}\tilde{\mathcal{C}} - \Lambda_3^{2P}) . \quad (4.16)$$

Integrating now over the dynamics at node 3, we recover in particular the F-term for \mathcal{N} that reads

$$h\Lambda_1^2(\det \mathcal{N})^{\frac{1}{P}}\mathcal{N}^{-1} + \lambda_3(\det \mathcal{N})\mathcal{N}^{-1} = 0 . \quad (4.17)$$

We do get supersymmetric vacua on its mesonic branch $\lambda_3 \neq 0$, while we get non-supersymmetric states on the baryonic branch, where we assume that $(\det \mathcal{N})^{\frac{1}{P}}\mathcal{N}^{-1} \sim 1$. Their meta-stability should be argued as in the SQCD case. Note that what plays the rôle of the mass is $h\Lambda_1^2$, hence the ISS regime of small mass compared to the dynamical scale should be attained for $h\Lambda_1^2 \ll \Lambda_3$. We will describe why we think it is possible to tune the D-brane couplings to attain such a regime after we discuss more details of the Calabi-Yau geometry in the next section.

In the non-supersymmetric states, the mesonic VEVs actually leave a left-over $U(1)^{P-1}$ gauge symmetry which would be classically enhanced to $SU(P)$ because all eigenvalues coincide at the minimum. Quantum effects should however prevent this from happening, along the lines of [34].

5. Gravity dual

In this section, we describe the gravity dual to the field theory we have studied in the previous sections. The \mathbb{Z}_2 orbifold of the conifold is described by equation (2.10), which we re-write below for convenience

$$(xy)^2 = zw . \quad (5.1)$$

As we have seen, the gauge theory (for $P = M$, which is the case we will focus on from now on) has three different interesting classes of vacua: i) the baryonic branch on nodes 1 and 3, which exhibits confinement and chiral symmetry breaking, ii) the mesonic branch on nodes 1 and 3, which gives rise to a Coulomb phase with gauge group $U(1)^{P-1}$, and iii) the mixed branch, where one finds meta-stable dynamical supersymmetry breaking vacua.

For class i), we expect a gravity dual with a geometric transition description along the lines of [23] (see also [43, 44]), where the branes disappear and are replaced by fluxes. The IR physics is then captured by the flux superpotential [45] in a smooth background geometry.

The solutions in class ii) will instead have a description with explicit probe D5 branes wrapped on a \mathbb{P}^1 . The geometrical moduli space of the \mathbb{P}^1 (raised to an appropriate power and symmetrized), reproduces the moduli space of the gauge theory.

Finally, for class iii), we will propose a gravity dual which incorporates and generalizes the strategy of [13].

We will see that the flux superpotentials in the appropriate deformations of (5.1) reproduce the low-energy Taylor-Veneziano-Yankielowicz (TVY) superpotential [46] of the coupled super-QCD theories.

5.1 Effective superpotential and basic properties of the geometry

On the gauge theory side, we can derive the low-energy superpotential as follows. Recall that for $SU(N_c)$ SQCD with N_f flavors and meson superfield \mathcal{M} , the effective superpotential

is [46]

$$W = -(N_c - N_f)S + S \log \left(\frac{S^{N_c - N_f}}{\Lambda^{3N_c - N_f} \det \mathcal{M}} \right) . \quad (5.2)$$

There is actually an ambiguity in the linear term in the glueball superfield S , coming from the possibility of shifting the bare gauge coupling; we will use this freedom to fix the coefficient in a way that makes sense from the dual gravity perspective. In the case that the flavors become massive with (non-degenerate) mass matrix m , by integrating them out and matching, one easily sees that the new effective superpotential should take the form

$$W \rightarrow -N_c S + S \log \left(\frac{S^{N_c}}{\Lambda^{3N_c - N_f} \det m} \right) . \quad (5.3)$$

We note that in the case $N_c = N_f$, (5.2) reproduces the quantum deformed mesonic branch — S acts as a Lagrange multiplier enforcing the condition

$$\det \mathcal{M} = \Lambda^{2N_c} . \quad (5.4)$$

The gauge theory at the end of our cascade is more complicated than massive super-QCD, consisting of three interacting gauge sectors. However, it simplifies in various limits. In the case that we go to the baryonic branch of nodes 1 and 3, i.e. class i) of the solutions above, the low-energy effective theory simply consists of a pure $SU(P)$ gauge theory arising from node 2. The effective superpotential we expect, by analogy with [23], is

$$W = \frac{k}{g_s} S_2 + P S_2 \log S_2 . \quad (5.5)$$

We fixed the coefficient of the term linear in S_2 in a way that will match the gravity expectations, as we explain below. Solving $\partial_S W = 0$ yields the P vacua characteristic of gaugino condensation in pure $\mathcal{N} = 1$ $SU(P)$ gauge theory.

We can also write a simple model superpotential for the class ii) solutions. Let us imagine working in the regime where Λ_2 is very small (so the $SU(P)$ symmetry of node 2 is viewed as a global symmetry). The gauge groups at nodes 1 and 3 both have $N_f = N_c$. From the quartic superpotential, we furthermore see that the effective mass matrix m for the quarks at node 3 (which we take to be the node eventually responsible for DSB) is the $P \times P$ meson matrix of node 1, $\mathcal{M} = X_{21} X_{12}$.

Then we expect an effective superpotential describing the mesonic branch of node 1 to be

$$W_1 = S_1 \log \left(\frac{\det \mathcal{M}}{\Lambda_1^{2P}} \right) . \quad (5.6)$$

Similarly, the effective superpotential describing the glueball superfields associated to node 3 will be

$$W_3 = \frac{k}{g_s} S_3 + S_3 \log \left(\frac{S_3^P}{\Lambda_3^{2P} h^P \det \mathcal{M}} \right) . \quad (5.7)$$

The total effective superpotential is

$$W_{\text{tot}} = W_1 + W_3 \quad (5.8)$$

and provides a coupling between the two sectors via the dual role of the \mathcal{M} matrix, which is a meson superfield for node 1 and a flavor mass term for node 3. Note that the symmetry between nodes 1 and 3 is restored once we extremize the above superpotential, which amounts to being in the supersymmetric states ii).

It is interesting to ask, how should one derive the superpotentials (5.5) and (5.8) directly on the gravity side? Namely, we should look for a set of fluxes and geometric moduli that reproduce the above superpotentials via the flux-induced Gukov-Vafa-Witten (GVW) superpotential [45]

$$W \propto \int G_3 \wedge \Omega \tag{5.9}$$

where $G_3 = F_3 - \tau H_3$ and for simplicity we fix the IIB axio-dilaton to be $\tau = \frac{i}{g_s}$. We first focus on the more involved (5.8) and then make some comments about the simpler (5.5). Our singularity has three independent 2-cycles, as can be seen most easily from the toric web diagram explained in appendix B. We will call \mathcal{C}_1 the cycle over which one wraps the fractional brane corresponding to the rank assignment $(1, 0, 0, 0)$ on the quiver. Similarly, we call \mathcal{C}_3 the 2-cycle corresponding to the $(0, 0, 1, 0)$ brane. Lastly, a convenient choice is to call \mathcal{C}_2 the cycle corresponding to the rank assignment $(0, 1, 1, 0)$.¹¹ Each of these 2-cycles can be viewed as the base of B-cycles B_1, B_2 and B_3 . These B-cycles are noncompact, but we will imagine compactifying them as in [41]. Alternatively, we could work with a long distance cut-off ρ_c on the noncompact geometry, which is mapped to a renormalization scale μ by the usual relation $\rho_c = 2\pi l_s^2 \mu$, and would define for us the bare gauge theory parameters. There is also a dual basis of three compact 3-cycles, the A-cycles A_1, A_2 and A_3 .

Since the branes wrapping on the 2-cycles \mathcal{C}_1 and \mathcal{C}_3 are deformation branes, we expect the dual 3-cycles A_1 and A_3 to have moduli controlling their deformations. These basically describe two conifold singularities. The periods in such conifold geometries satisfy

$$\int_{A_i} \Omega = z_i, \quad \int_{B_i} \Omega = \frac{z_i}{2\pi i} \log(z_i) + \text{regular} \quad i = 1, 3. \tag{5.10}$$

We identify the z_1 and z_3 coordinates on the moduli space with the glueball superfields S_1 and S_3 above. The brane wrapped on the 2-cycle \mathcal{C}_2 on the other hand is an $\mathcal{N} = 2$ fractional brane, and hence, much as in the $\mathbb{C} \times \mathbb{C}^2/\mathbb{Z}_2$ geometry, its dual A_2 cycle does not deform, and the modulus associated to it vanishes on-shell.

We expect that the superpotential (5.8) should be derived by choosing appropriate RR and NS three-form fluxes. Due to the complete symmetry between node 1 and node 3 in the $P = M$ case we are considering, several different fractional brane bases are equivalent for reproducing the superpotential we are after. In what follows, we choose for convenience the basis where the rank assignment in figure 4 is obtained considering P fractional branes of type $(0, 0, 1, 0)$ and P fractional branes of type $(1, 1, 0, 0)$, the latter corresponding to the cycle $\mathcal{C}_4 = \mathcal{C}_1 + \mathcal{C}_2 - \mathcal{C}_3$ (looking at the toric web in appendix B, figure 12, one can

¹¹The asymmetry between nodes 1 and 3 with respect to the cycle \mathcal{C}_2 might be disturbing for the reader. A more symmetric situation could be achieved by identifying the 2-cycles on the toric web after performing a flop transition on one of the two conifold singularities. However, our choice of basis is the one making the following arguments the clearest.

easily recognize that such cycle indeed corresponds to an $\mathcal{N} = 2$ fractional brane). This choice enables us to get the superpotential (5.8) more straightforwardly. We propose

$$\int_{A_3} F_3 = P \quad (5.11)$$

and

$$\int_{B_3} H_3 = -k \quad (5.12)$$

as the choices of RR and NS flux, respectively. This is the expected geometric transition, arising from adding P branes of the $(0, 0, 1, 0)$ kind. The dependence on the meson field is reproduced if one adds P probe D5 branes of $\mathcal{N} = 2$ type to the geometry; as anticipated, we want to add P $(1, 1, 0, 0)$ branes, whose corresponding cycle is $\mathcal{C}_4 = \mathcal{C}_1 + \mathcal{C}_2 - \mathcal{C}_3$.

The meson then appears in the superpotential in a way fixed by a standard disc computation, described in [47, 48], and precisely reproducing the field theory result. Let us explain in some more detail how the meson dependence arises in the flux superpotential. Our arguments follow closely the ones presented in [48] for a similar model. There it is shown that $\mathcal{N} = 2$ fractional branes wrapped on a 2-cycle \mathcal{C} which is at the base of a (non-compact) B-cycle, when they are scattered on their moduli space, give rise to the following fluxes

$$\int_A G_3 = 0, \quad \int_B G_3 = i \log(\det \mathcal{M}) \quad (5.13)$$

where \mathcal{M} parametrizes the positions of the D5-branes along the curve of A_1 singularities.¹²

Thus, we expect the fluxes in our geometry to change accordingly

$$\begin{aligned} \int_{B_1} G_3 = 0 & \quad \rightarrow \quad \int_{B_1} G_3 = i \log(\det \mathcal{M}). \\ \int_{B_3} G_3 = i \frac{k}{g_s} & \quad \rightarrow \quad \int_{B_3} G_3 = i \frac{k}{g_s} - i \log(\det \mathcal{M}) \end{aligned} \quad (5.14)$$

The integral of G_3 over B_2 , though non vanishing, does not enter the superpotential because the integral of Ω over A_2 is vanishing. A word of caution has to be said regarding the integrals over the non-compact B-cycles. Besides the UV cut-off, there is an additional short-distance cut-off that accounts for the break-down of the gravity approximation very close to the D5-branes. We have not written this cut-off dependence explicitly on the right hand side of the equations (5.14), but it can be shown to combine with the data above to give the expected result in the superpotential. Indeed, plugging the supergravity fluxes (5.11),(5.14) and the geometric periods (5.10) into (5.9) we get the expected field theory result (5.8).

Let us now briefly discuss the class i) solutions. The superpotential (5.5) clearly indicates that there should be F_3 flux through only one of the 3-cycles, namely the one dual to the $\mathcal{C}_2 - \mathcal{C}_3$ cycle, over which one wraps a $(0, 1, 0, 0)$ fractional brane. There is also H_3 flux through its corresponding non-compact cycle $B_2 - B_3$. The other cycle A_1 , having no 3-flux, can shrink to zero size without introducing singularities in the full

¹²We use A_1 to denote a compact 3-cycle as well as a $\mathbb{C}^2/\mathbb{Z}_2$ singularity. We hope the reader can easily discern the meaning from the context.

supergravity solution (much as in the conformal conifold theory [49]). We then just have to identify the modulus z controlling the size of the blown-up 3-cycle with S_2 .¹³ As before, plugging the supergravity fluxes into the GVW formula we get the correct field theory superpotential (5.5).

5.2 Couplings and scales

In §2.1 and §4.2 we discussed several regimes, such as $\Lambda_1 \gg \Lambda_3 \gg \Lambda_2$ and $\Lambda_3 \gg \Lambda_1 \gg \Lambda_2$. How can we obtain them? Given the identification of cycles in the geometry and fractional branes discussed after (5.9), it follows that the gauge couplings for the three gauge groups satisfy

$$\frac{1}{g_{1,3}^2} \sim \int_{\mathcal{C}_{1,3}} B_2, \quad \frac{1}{g_2^2} \sim \int_{\mathcal{C}_2 - \mathcal{C}_3} B_2. \quad (5.15)$$

It is clear that we have room for tuning the above quantities in order to reach any such regime.

Recall however that we also want to have $h\Lambda_1^2 \ll \Lambda_3$. We note that in the full 4-node quiver theory, there is an additional tunable dimensionless parameter (which one can think of as g_s), but there are also two additional dimensionful couplings (Λ_4 and h). As long as h varies when one changes the additional parameter, this suffices to show that the various requirements we have placed on the couplings and scales (for our analysis to apply) can indeed be met in the string construction.

5.3 Supersymmetric vacua

We now describe how the supersymmetric vacua emerge from our gravity description. The minima of the flux superpotential for vacua of class ii) are easy to work out. From the TVY superpotential (5.8), integrating out the mesons, one sees that the solutions lie where $S_1 = S_3$. Hence, we expect the relevant geometry to describe two conifolds of equal size. The simple perturbation

$$(xy)^2 = zw \rightarrow (xy - \epsilon)^2 = zw \quad (5.16)$$

accomplishes this, where ϵ is identified with the dynamical scale of the confining gauge groups. And from the identification of the GVW flux superpotential with the TVY superpotential, we see that the deformation (5.16) is indeed the solution of the equations of motion for the complex structure moduli — we get two S^3 A-cycles which are deformed to finite but equal size.

How do we incorporate the meson field? The $U(1)^{P-1}$ gauge group of the Coulomb branch of the $SU(P)$ node 2, is manifested in terms of P fractional probe D5 branes. They wrap the small \mathbb{P}^1 in the curve of singularities visible in the geometry (5.16), located at $xy = \epsilon$.¹⁴

¹³This modulus is essentially z_3 as in (5.10). However in the present case it is associated to S_2 rather than S_3 . Indeed, it is the initial charges and the particular vacuum one is choosing that selects which scales S_i are relevant and how they have to be identified with the geometrical moduli.

¹⁴This is precisely the cycle $\mathcal{C}_1 + \mathcal{C}_2 - \mathcal{C}_3$. Note that its dual A-cycle, because of the on-shell relation $S_1 = S_3$, has a vanishing integral of Ω , as should be the case for $\mathcal{N} = 2$ fractional branes.

The dual of the class i) vacua, is also easy to describe. The IR geometry is governed by the deformation

$$(xy)^2 = zw \rightarrow (xy)(xy - \epsilon) = zw \tag{5.17}$$

where ϵ is now related to the dynamical scale of the node 2 $SU(P)$ factor. There are no probe branes.

The deformed geometries (5.16)–(5.17) are derived in appendix A from the gauge theory.

5.4 Non-supersymmetric vacuum

How should we think about the meta-stable non-supersymmetric states of the dual field theory? In a somewhat similar context, involving the smooth gravity dual of a confining gauge theory, it was observed in [13] that one can sometimes make meta-stable non-supersymmetric states by adding anti-brane probes. As long as the charges at infinity are fixed in the gravity description, any such non-supersymmetric states must be interpreted as particular vacuum states in the supersymmetric gauge theory (at large 't Hooft coupling).

In the case we have focused on, the three-node quiver with occupation numbers $P - P - P$, the options are somewhat limited. The gravity dual carries $N = kP$ units of D3 charge. If we add an anti-D3 probe, to maintain the same total charge, we would be forced to add also a D3 probe, and the two would perturbatively annihilate. In fact, the same situation holds if we add $2, 3, \dots, P - 1$ anti-D3 probes. However, the addition of P anti-D3 probes introduces another option: we can “jump the fluxes” so

$$\int_{A_3} F_3 = P, \int_{B_3} H_3 = -k \rightarrow \int_{A_3} F_3 = P, \int_{B_3} H_3 = -(k + 1) \tag{5.18}$$

while adding the P anti-D3 probes. In this case, the total charges at infinity are conserved. Therefore, this is another state in the same supersymmetric theory we have been studying.

The mesonic branch characterized by the fluxes above also contains P D5 probes, wrapped around small cycles in the curve of A_1 singularities. This is consistent with the left-over gauge symmetry present in the supersymmetry breaking vacua of §4.2. By definition, at the quiver point in moduli space the fractional brane charges are aligned with the D3 charges. So the D5s will attract the P anti-D3 probes. The result will be a state with the anti-D3 probes dissolved in the D5s as gauge flux. As described in §4.2, the meta-stable states only exist in the case $P = M$ in the field theory, and in that case, the preferred configuration has P equal eigenvalues of the meson matrix. We therefore expect the P D5s to wrap a single small \mathbb{P}^1 \mathcal{C} in the locus of A_1 singularities, and manifest a worldvolume gauge field configuration with

$$\int_{\mathcal{C}} \mathcal{F} = -P \tag{5.19}$$

which, via the Chern-Simons couplings in the D5 action, accounts for the P units of anti-brane charge.

This proposal matches nicely with the field theory. In particular, it is interesting that it is impossible to get meta-stable states by adding $1, \dots, P - 1$ anti-branes, while adding

P leads to a natural candidate. This matches the fact that in the field theory, the only (known) meta-stable supersymmetry breaking vacuum has an energy $\sim P$ in units of the dynamical scale. It would be nice to find a precise gravity solution describing these states.

Note that there are two equivalent meta-stable vacua, which result from exchanging nodes 1 and 3. They are just mapped to each other by the \mathbb{Z}_2 symmetry of the geometrical background.

The reader may be confused about the distinction between the SUSY breaking dynamics here, and that in [13]. There, the leading effect on anti-D3 probes involved polarizing via the Myers effect [50] into 5-branes wrapping (contractible) S^2 s. When there are few probe branes relative to the background RR flux, the Myers potential exhibits meta-stable states. Here, we claim there is a stronger effect, which can yield bound states even for a number of anti-D3s strictly comparable to the background flux. A heuristic argument in favor of this is as follows. For large P , the three-form fluxes are dilute, and the gradient of the Myers potential encouraging an anti-D3 to embiggen is very mild. In this situation, it seems quite reasonable that the attraction to the fractional D5s will provide a stronger force on the anti-D3. Indeed in flat space, this system is T-dual to the D0-D2 system, which enjoys a long range attractive force and exhibits a bound state which has binding energy that is an $\mathcal{O}(1)$ fraction of the original brane tension energies [51]. If the probe anti-D3s are close enough to the D5s, this attractive force should be a stronger effect than the force encouraging the anti-D3s to polarize. It is the presence of the background fractional D5s and their attraction to the anti-D3s, that suggests to us that this system and the one in [13] behave differently. We consider this as supporting evidence for the identification of the supersymmetry breaking states on the gravity and gauge theory dual sides.

We briefly note that in principle we have the possibility of adding a multiple nP of anti-D3 branes while shifting $\int_{B_3} H_3$ accordingly. We do not have a decisive argument against stability (which is what we would expect, since these states are not seen in the gauge theory), but we note that the binding energy per unit anti-D3 probe decreases as the number of probes is increased, so that eventually the Myers effect is likely to take over.

5.5 Comments on the full solution

After providing the correct fluxes reproducing the low energy effective dynamics of the dual gauge theory, one might ask what the complete supergravity solution describing our theory might be. This depends, of course, on which branches/vacua one is looking at.

The solutions characterizing branch i) in fact fit into a well known general class of models. The self-dual 5-form satisfies a Bianchi identity

$$d\tilde{F}_5 = H_3 \wedge F_3 + \rho_{D3} \tag{5.20}$$

where the first term on the r.h.s. is the flux-induced D3 charge, and the second term measures local charge density in probe D3 branes (with an appropriate normalization). For our setting, in the absence of explicit probe branes, the complete D3 charge of N is accounted for by the fact that $\int H_3 \wedge F_3 = kP = N$.

The full IIB solution is very similar to the one discussed in [23], and falls in the general class of solutions described in [52, 41]. The metric takes the form

$$ds^2 = e^{2A(r)} \eta_{\mu\nu} dx^\mu dx^\nu + e^{-2A(r)} \tilde{g}_{mn} dy^m dy^n \quad (5.21)$$

with \tilde{g}_{mn} the unit metric on the cone over an appropriate Einstein manifold (in this case, the \mathbb{Z}_2 orbifold of $T^{1,1}$), or its deformation, in the non-conformal case; for class i) vacua this should be a metric on the deformed space (5.17). The 5-form is determined in terms of the warp factor $A(r)$ via the equations

$$\tilde{F}_5 = (1 + *) (d\alpha \wedge dx^0 \wedge dx^1 \wedge dx^2 \wedge dx^3) \quad (5.22)$$

with

$$\alpha = e^{4A(r)} . \quad (5.23)$$

The three-form flux $G_3 = F_3 - \tau H_3$ is imaginary self-dual

$$*_6 G_3 = i G_3 \quad (5.24)$$

and purely of type (2,1). $A(r)$ varies over a range dual to the range of scales covered in the RG cascade, with

$$e^A|_{\text{tip}} = e^{-\frac{4\pi k}{3Pg_s}} . \quad (5.25)$$

The axio-dilaton $\tau(y)$ is a constant in the background, which we can choose at infinity (in the compact solutions, it is fixed by the flux superpotential and additional data involving fluxes on other cycles in the compact manifold).

A fully backreacted supergravity solution for class ii) vacua is more difficult to achieve. We have again P deformation branes which would provide a solution very similar to the one above, with the only difference that \tilde{g}_{mn} should now be a metric on the deformed space (5.16). The problem is that there are $P \mathcal{N} = 2$ branes around, too. They do not couple to the dilaton, which should then remain constant, and should also still provide an imaginary self-dual three-form flux. What is hard to find is the explicit form of the metric. Supergravity solutions for $\mathcal{N} = 2$ fractional branes on undeformed orbifold-like singularities are well known [53]. However, in the present case one should compute their backreaction on the already deformed geometry (5.21). It would be very interesting to find solutions of this kind, since they could play a rôle in several different contexts. However, such a challenge is beyond the scope of the present paper.

6. Conclusions

When leaving the realm of supersymmetric vacua, we are no longer guaranteed that physics will not change qualitatively when parameters (such as the 't Hooft coupling) are varied significantly. Hence a non-supersymmetric meta-stable state which can be shown to exist when the parameter is small (i.e. on the gauge side of the duality), might well not be visible anymore when the parameter becomes large (i.e. on the gravity/string side of the duality), and vice-versa.

We have presented in this paper a simple example of a gauge/gravity dual pair where we could provide evidence on both sides for the existence of meta-stable states displaying dynamical supersymmetry breaking. From the quiver gauge theory point of view, we are in a limiting case of the theories studied by [27]. Meta-stability in the $N_f = N_c$ SQCD case that interests us was briefly discussed in [27], the most convincing argument in favor of it being the relation, by decoupling of an additional (more) massive flavor, to the more controlled case of $N_f = N_c + 1$. In the latter theory, meta-stability can be checked by a direct one-loop computation. Following the meta-stable state as the mass of one pair of chiral superfields is increased, we end up exactly on the “baryonic branch” of the $N_f = N_c$ theory, the point that we have argued would be the farthest from the SUSY vacua. We consider this to be suggestive evidence that the states we have discussed are not unstable in the gauge theory regime. Meta-stability could be set on a firmer footing by understanding the higher order (in $1/\Lambda^2$) corrections to the Kähler potential. In addition, identifying the optimal path from the meta-stable vacuum to the SUSY vacua would give an estimate for the lifetime of the meta-stable vacuum.

On the gravity side, we have provided geometrical arguments that show that there are non-supersymmetric states with the same quantum numbers as the field theory ones, and which lack any obvious perturbative instabilities. We have a background geometry

$$(xy - \epsilon)^2 = zw \tag{6.1}$$

which can be seen as being created by two sets of P fractional branes. It has a line of singularities which, in our set up, supports another set of P fractional branes, of $\mathcal{N} = 2$ kind. The latter can be expected to have a significant backreaction. Indeed, in the supersymmetric case, the system where all the fractional branes do not explore their moduli space (but are on the baryonic branch instead) should correspond to the geometry where only one 3-cycle is blown up. On their mesonic branch, the $\mathcal{N} = 2$ fractional branes are still scattered as probes, though the geometry deformed by the presence of sources is clearly more complicated.

The non-supersymmetric states correspond to the $\mathcal{N} = 2$ fractional branes, which are really D5-branes wrapped on small \mathbb{P}^1 s, carrying an additional gauge flux with anti-D3 charge on the \mathbb{P}^1 . The attraction between the anti-D3s and the wrapped D5-branes, and the precise matching of fluxes (P anti-D3-branes for P D5-branes), makes stability plausible.

Note that in [13], a similar story was presented, but the main difference there was that a probe computation revealed that, in order to ensure meta-stability, the number p of anti-D3-branes must be much smaller than the number P of fractional branes originally creating the smooth geometry of the deformed conifold. When p is increased, the anti-D3-branes eventually polarize into a big NS5-brane due to the Myers effect and decay perturbatively. While in both cases for P anti-D3-branes the probe approximation is clearly not good, in the set up of this paper we could argue that there is a competing effect which can overcome the desire of the anti-D3s to embiggen, namely their attraction towards the wrapped D5s. Hence, also on the gravity side, the non-supersymmetric states would naively be meta-stable.

Actually, we could imagine going further on the gravity side. Not surprisingly, the geometry (6.1) is simply obtained from the deformed conifold

$$xy - \epsilon = uv \tag{6.2}$$

by performing the \mathbb{Z}_2 orbifold acting as $u \rightarrow -u, v \rightarrow -v$. Thus the full metric and fluxes of the background geometry should be straightforwardly obtainable, through identifications and the method of images, from the solution of Klebanov and Strassler [23]. In order to describe the meta-stable vacua we are after, we would then have to introduce P wrapped D5-branes (as, e.g., in [48]) with the appropriate anti-D3 flux. This set up would not take into account the (possibly large) backreaction of the additional probes, but should already present the rough features of the system we want to describe.

For instance, we could be interested in the spectrum of gauge invariant operators in this supersymmetry breaking vacuum. In particular, we should find the massless fermion of broken supersymmetry, the goldstino. Note that this massless mode should not be looked for among the supergravity modes (using, for instance, the methods of [54]), but among the world-volume modes of the probe branes. The situation is similar to [21], albeit for different reasons.

Though we have focused on the simple example of the \mathbb{Z}_2 orbifold of the conifold throughout the paper, it seems likely that one can find many similar cases. Perhaps in some of them, one will be able to find analogues of the more quantitatively accessible ISS vacua in the free magnetic range $N_c < N_f < \frac{3}{2}N_c$. A plausible way of achieving this goal is to consider our 3-node theory as a piece of a larger quiver as contemplated at the end of §2.1. Such an extended theory could have additional gauge groups, more flavors for node 3 and appropriate superpotential interactions. The extra flavors may become massive dynamically by a mechanism similar to the one in §2.1.

It would also be very interesting to find examples of meta-stable states similar to those analyzed in this paper in configurations where there is no stable supersymmetric vacuum, but instead (naively) a runaway behavior, such as the $Y^{p,q}$ theories studied in [14–16, 18, 19].

Acknowledgments

We are happy to thank Sergio Benvenuti, Francesco Bigazzi, Gia Dvali, Jarah Evslin, Gabriele Ferretti, Luciano Girardello, Yang-Hui He, Nissan Itzhaki, Igor Klebanov, Liam McAllister, Angel Uranga, Herman Verlinde and especially Ofer Aharony and Oliver DeWolfe for very helpful discussions. R.A. and M.B. are partially supported by the European Commission FP6 Programme MRTN-CT-2004-005104, in which R.A. is associated to V.U. Brussel. R.A. is a Research Associate of the Fonds National de la Recherche Scientifique (Belgium). The research of R.A. is also supported by IISN - Belgium (convention 4.4505.86) and by the “Interuniversity Attraction Poles Programme –Belgian Science Policy”. M.B. is supported by Italian MIUR under contract PRIN-2005023102 and by a MIUR fellowship within the program “Rientro dei Cervelli”. S.F. is supported by the DOE under contract DE-FG02-91ER-40671. He would like to dedicate this work to Belén Ariana Franco

and her mom Carla. The research of S.K. is supported by the DOE under contract DE-AC03-76SF00515, the NSF under grant PHY-0244728, and a David and Lucile Packard Foundation Fellowship for Science and Engineering. He is grateful to the KITP for kind hospitality while this research was being carried out.

A. Geometry of the moduli space

The geometry of the moduli space can be derived from the chiral ring of the gauge theory with F-term relations, both at the classical and quantum levels. In order to simplify the discussion we consider a single D3-brane probe (in the full problem, the coordinates we discuss become the eigenvalues of mesonic operators and the moduli space corresponds to the symmetric product of several copies of the same geometry).

The moduli space is determined by finding gauge invariant variables, writing down any algebraic relations among them and then using F-term equations to simplify the relations even further.

Let us begin with the classical moduli space. We can define four quadratic gauge invariant variables

$$\begin{aligned} x &= X_{12}X_{21} \quad , \quad y = X_{23}X_{32} \\ z &= X_{34}X_{43} \quad , \quad w = X_{41}X_{14} \end{aligned} \tag{A.1}$$

In addition, there are two quartic gauge invariants

$$u = X_{12}X_{23}X_{34}X_{41} \quad , \quad v = X_{14}X_{43}X_{32}X_{21} \tag{A.2}$$

There is an algebraic relation among them

$$xyzw = uv \tag{A.3}$$

The F-term equations following from the tree-level superpotential (2.14) imply that $x = z$ and $y = w$. Hence, (A.3) becomes

$$(xy)^2 = uv \tag{A.4}$$

This is the classical geometry derived in §2.2 by the orbifold procedure. We can now move on and derive the deformed geometries from the quantum gauge theories.

A relevant case is when we have two sets of fractional branes, say M of type $(1, 0, 0, 0)$ and P of type $(0, 0, 1, 0)$. In order to study the geometry, we add a single D3-brane probe. The resulting quiver is shown in figure 11. The “SU(1)” nodes are not really gauge groups but have the effect of adding chiral matter.¹⁵

How is (A.4) modified in the quantum theory? Nodes 1 and 3 have $N_f < N_c$ and hence ADS superpotentials are generated. Starting again from (A.3), we can study how it is deformed by using the F-terms that follow from $W_{\text{tree}} + W_{\text{dyn}}$. The strong dynamics of nodes 1 and 3 is described in terms of their mesons (which we will later relate to the variables

¹⁵We adhere to the usual habit of neglecting the U(1) factors at every node as soon as non-trivial gauge dynamics sets in.

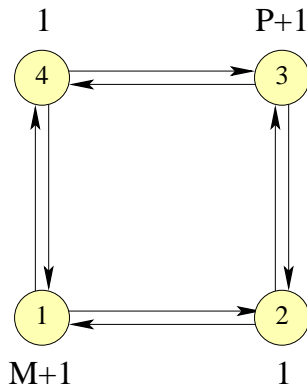

Figure 11: Quiver diagram for M $(1, 0, 0, 0)$ and P $(0, 0, 1, 0)$ branes after adding one D3-brane probe.

used to write down the equation of the singularity) $\mathcal{M}_{ij} = X_{i1}X_{1j}$ and $\mathcal{N}_{ij} = X_{i3}X_{3j}$ with $i, j = 2, 4$.

Adding the tree-level and dynamical superpotentials, we obtain

$$\begin{aligned}
 W = & h (\mathcal{M}_{22}\mathcal{N}_{22} + \mathcal{M}_{44}\mathcal{N}_{44} - \mathcal{M}_{24}\mathcal{M}_{42} - \mathcal{N}_{24}\mathcal{N}_{42}) + \\
 & + (M - 1) \left(\frac{\Lambda_1^{3M+1}}{\det \mathcal{M}} \right)^{\frac{1}{M-1}} + (P - 1) \left(\frac{\Lambda_3^{3P+1}}{\det \mathcal{N}} \right)^{\frac{1}{P-1}} .
 \end{aligned} \tag{A.5}$$

The F-terms altogether imply

$$\det \mathcal{M} = \left(\frac{\Lambda_1^{3M+1}}{h^{M-1}} \right)^{\frac{1}{M}} = \epsilon_1 \quad , \quad \det \mathcal{N} = \left(\frac{\Lambda_3^{3P+1}}{h^{P-1}} \right)^{\frac{1}{P}} = \epsilon_3 \tag{A.6}$$

and

$$\mathcal{M}_{22} = \mathcal{N}_{44} \quad , \quad \mathcal{M}_{44} = \mathcal{N}_{22} . \tag{A.7}$$

We have the following identifications

$$x = \mathcal{M}_{22} \quad , \quad y = \mathcal{N}_{22} \quad , \quad z = \mathcal{N}_{44} \equiv x \quad , \quad w = \mathcal{M}_{44} \equiv y \tag{A.8}$$

where we have used (A.7), and

$$u = \mathcal{M}_{42}\mathcal{N}_{24} \quad , \quad v = \mathcal{M}_{24}\mathcal{N}_{42} . \tag{A.9}$$

We note that (A.6) implies that $\mathcal{M}_{24}\mathcal{M}_{42} = \mathcal{M}_{22}\mathcal{M}_{44} - \epsilon_1 \equiv xy - \epsilon_1$, and $\mathcal{N}_{24}\mathcal{N}_{42} = \mathcal{N}_{22}\mathcal{N}_{44} - \epsilon_3 \equiv xy - \epsilon_3$. Using again (A.7), we conclude that the deformed geometry corresponds to

$$(xy - \epsilon_1)(xy - \epsilon_3) = uv . \tag{A.10}$$

For generic deformation parameters ϵ_1 and ϵ_3 , the above geometry is completely regular. However, for $\epsilon_1 = \epsilon_3$ it has a line of A_1 singularities on the locus defined by $xy - \epsilon_1 = 0$. On the locus of singular points, which contain small \mathbb{P}^1 s, we can then add the fractional

branes of $\mathcal{N} = 2$ kind. This corresponds to the class ii) vacua discussed in §5. Note that the simplest way to satisfy the relation $\epsilon_1 = \epsilon_3$ is when the ranks and scales are equal, $P = M$ and $\Lambda_1 = \Lambda_3$.

We can use these results also to determine the deformation of the geometry once we are in the baryonic branch for both nodes 1 and 3, which corresponds to the class i) vacua. This leaves a single $SU(M)$ confining gauge group, node 2, behind. As argued in §5.1, this is expected to correspond to a single deformation. In fact, after rotating the quiver such that nodes are relabeled according to $(1, 2, 3, 4) \rightarrow (4, 1, 2, 3)$, the deformation follows from setting $P = 0$ in our previous analysis. Hence, (A.10) reduces to

$$(xy - \epsilon)(xy) = uv . \tag{A.11}$$

It is straightforward to check that there is a remaining conifold singularity in the moduli space. From a field theory point of view, this is expected to be manifest when the dynamical scale of the leftover node goes to infinity (equivalently when $\epsilon \rightarrow \infty$). This corresponds to studying the theory at energy scales much lower than Λ_2 . Using rescaled variables $\tilde{x} = \epsilon^{1/2}x$ and $\tilde{y} = \epsilon^{1/2}y$, (A.11) becomes the conifold equation $\tilde{x}\tilde{y} = uv$.

B. Toric geometry, (p, q) webs and complex deformations

This appendix presents basic notions about toric singularities and their description in terms of (p, q) webs. The goal is to provide a brief description of practical rules necessary to get an intuitive understanding of the basic geometric features of a singularity and its possible deformations. We refer the reader to [55–57] for more detailed presentations of toric geometry and to [58, 59] for comprehensive expositions of the connections between web diagrams and toric geometry. These ideas are not crucial for understanding the current paper but are useful for identifying the cycles over which branes are wrapped. They also simplify the study of generalizations of our model.

A d -complex dimensional toric variety V^d is a generalization of a complex projective space, defined as

$$V^d = (\mathbb{C}^n - F) / \mathbb{C}^{*(n-d)} \tag{B.1}$$

in which we quotient by $(n - d)$ \mathbb{C}^* actions and we remove a set of points F in order for such quotient to be well defined. The action of $\mathbb{C}^{*(n-d)}$ on the \mathbb{C}^n coordinates is defined by $(n - d)$ charge vectors Q^a as

$$\lambda_a : (x_1, \dots, x_n) \rightarrow (\lambda_a^{Q_1^a} x_1, \dots, \lambda_a^{Q_n^a} x_n), \quad a = 1, \dots, n - d . \tag{B.2}$$

The charges can be arranged into a matrix $Q = (Q_i^a)$. This approach to toric varieties is known as the holomorphic quotient.

Alternatively, we can perform the quotient by $\mathbb{C}^{*(n-d)}$ in two steps, decomposing each $\mathbb{C}^* = \mathbb{R}^+ \times U(1)$. This approach is called the symplectic quotient. We first fix the $\mathbb{R}^{+(n-d)}$ levels via a moment map

$$\sum_{i=1}^n Q_a^i |x_i|^2 = \xi_a, \quad a = 1, \dots, n - d \tag{B.3}$$

for some real parameters ξ_a . We refer to these equations D-terms. This is because they are actually the D-terms of an $\mathcal{N} = 2$ gauged linear sigma model (GLSM) with target space \mathbb{C}^n which reduces in the infrared to a non-linear sigma model whose target space is the toric variety V^d [60].

Finally, we quotient by the $U(1)^{(n-d)}$ action defined by the charge matrix Q (which gives the gauge groups and corresponding charges of the GLSM). Generic non-zero values of the ξ_a 's lead to a full resolution of the singularity. Setting them to non-generic values (i.e. with some linear combinations equal to zero) produces a partial resolution.

A simple way to represent a toric singularity is by means of a toric diagram. A toric diagram for a d -complex dimensional toric variety is a set of points in the integer lattice $\mathbf{N} = \mathbb{Z}^{(d)}$. The toric diagram consists of n vectors $\vec{v}_i, i = 1, \dots, n$. Each \vec{v}_i represents an homogeneous coordinate z_i . The \vec{v}_i 's satisfy linear relations of the form

$$\sum_{i=1}^n Q_a^i \vec{v}_i = 0 \tag{B.4}$$

with $Q_a^i \in \mathbb{Z}$. In other words, Q is given by the kernel of a matrix whose columns are the \vec{v}_i 's. The matrix Q computed this way, is precisely the one that determines the $U(1)^{(n-d)}$ action of the symplectic quotient.

When the toric variety is Calabi-Yau, the toric diagram is simplified. In fact the manifold is Calabi-Yau if and only if there exist a vector \vec{h} in the lattice \mathbf{M} dual to \mathbf{N} such that

$$\langle \vec{h}, \vec{v}_i \rangle = 1 \quad \forall \vec{v}_i . \tag{B.5}$$

In other words, the toric diagram lives on an $(n - 1)$ -dimensional hyperplane at unit distance from the origin. This means that the 3-complex dimensional toric Calabi-Yaus that we focus on are represented by toric diagrams that are effectively 2-dimensional.

A related approach to toric varieties is to construct them as n -dimensional torus fibrations T^n over some base spaces. For 3-complex dimensional toric varieties, the information about degenerations of the fibrations can be encoded in toric skeletons, also known as (p, q) webs [61, 62].

A web diagram is obtained by dualizing any triangulation of the toric diagram. Edges, nodes and faces of the toric diagram are respectively mapped to transverse edges, faces and nodes of the dual web. Different triangulations of the toric diagram, and hence different forms of the dual web, are related by flop transitions. Figure 12 illustrates these ideas with the example considered along the paper.

Every segment in the web is characterized by a pair of integers, the so called (p, q) charges. These charges determine the orientation of the segment $x : y = p : q$. In addition, (p, q) charge is conserved at every node in the web.

There is a T^2 fibration over every point in the web diagram. The additional circle action comes from the rotation on the phase of the normal line bundle. Lines in the web diagram indicate where one of the circles of the T^2 shrinks to zero. The entire T^2 vanishes at the points where two lines meet. Then, finite segments in the web correspond to \mathbb{P}^1 's and compact faces represent compact 4-cycles.

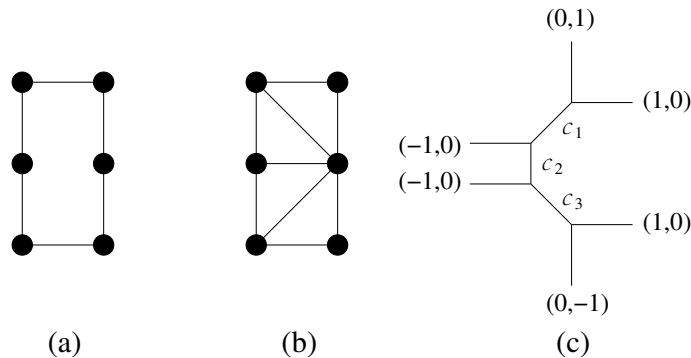

Figure 12: a) Toric diagram for the \mathbb{Z}_2 orbifold of the conifold. b) Triangulation of the toric diagram. c) (p, q) web with charges of external legs.

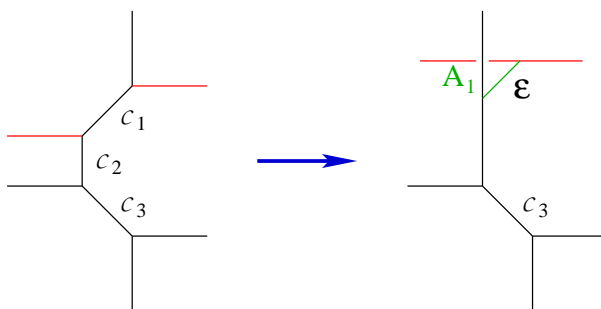

Figure 13: Deformation of the \mathbb{Z}_2 orbifold of the conifold given by $(xy)(xy - \epsilon) = uv$. The green segment represents an S^3 with volume proportional to its length.

In figure 12c), we have shown the basis of 2-cycles that we refer to in §5. Note that fractional branes wrapped on \mathcal{C}_1 and \mathcal{C}_2 have an orientation which can be represented by circling the segment anti-clockwise, while a brane wrapped on \mathcal{C}_3 should correspond to the segment being circled clockwise.

Web diagrams are very useful for identifying possible complex deformations, in which an S^2 makes a transition into an S^3 . They correspond to decompositions of the web into sub-webs in equilibrium (i.e. the sum of the (p, q) charges of external legs vanishes for each piece). Figure 13 shows the web description of the $(xy)(xy - \epsilon) = uv$ deformation, in which a single S^3 of size ϵ is generated. The leftover diagram corresponds to a conifold singularity, in agreement with the discussion in appendix A.

As a final example, figure 14 provides a pictorial representation for the $(xy - \epsilon)^2 = uv$ deformation. In this case, there are two S^3 's of equal size ϵ . The Coulomb branch of node 2 of the gauge theory corresponds to motion of the D5-branes (indicated in magenta) wrapped over the \mathbb{P}^1 along a curve of singularities, corresponding to the cycle $\mathcal{C}_1 + \mathcal{C}_2 - \mathcal{C}_3$.

C. Type IIA description

Many features of gauge theories become geometrical when they are engineered using brane setups. Recently, Type IIA configurations dual to meta-stable non-supersymmetric vacua

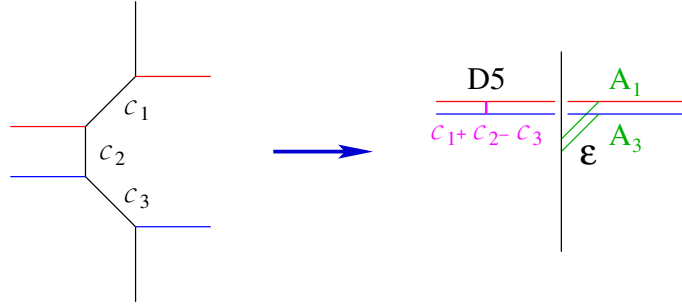

Figure 14: Deformation of the \mathbb{Z}_2 orbifold of the conifold given by $(xy - \epsilon)^2 = uv$. We show D5-branes wrapped over the \mathbb{P}^1 along the curve of singularities in magenta.

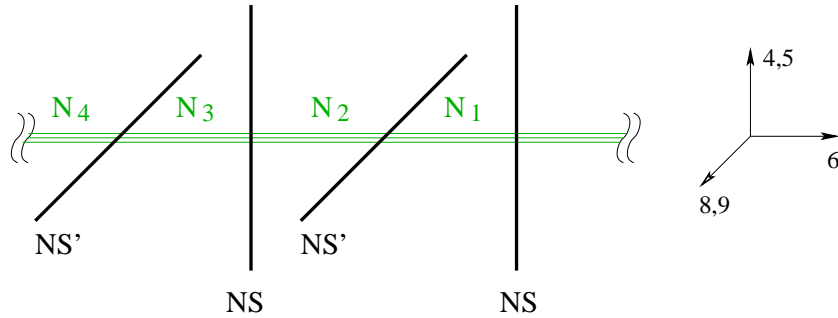

Figure 15: Type IIA brane configuration dual to the (N_1, N_2, N_3, N_4) quiver. D4-branes are shown in green. The x_6 direction is periodically identified.

of various gauge theories were constructed [63–65]. These construction allow a simple visualization of various aspects of the field theories such as vacuum energy, pseudo-moduli and their stabilization by a 1-loop effective potential. With this motivation, we proceed to construct the IIA dual of our gauge theory.

Regular and fractional D3-branes probing the \mathbb{Z}_2 orbifold of the conifold are T-dual to a system of D4-branes and relatively rotated NS5-branes in Type IIA. This configuration is shown, for arbitrary ranks of the gauge groups, in figure 15. NS-branes extend in $(0, 1, 2, 3, 4, 5)$, NS'-branes in $(0, 1, 2, 3, 8, 9)$ and D4-branes in $(0, 1, 2, 3, 6)$. The x_6 direction is compactified on a circle. Regular D3-branes become D4-branes extended along the entire x_6 circle, while fractional D3-branes map to D4-branes stretched between NS5-branes.

Figure 16 shows the configuration dual to the three node quiver of figure 4.

The mesonic branch has a simple realization in the brane configuration. It corresponds to combining the two sets of D4-branes at both sides of the left NS-brane and moving them in the 89 directions as shown in figure 17.¹⁶ Interestingly, if we focus on the rightmost piece of the setup, we identify the usual configuration dual to $SU(P)$ SQCD with massive flavors.¹⁷ The complex mass parameters correspond to the positions of the M D4-branes in 89. In this case, the mass matrix m is constrained by $\det m = h^P \Lambda_1^{2P}$ but the masses are dynamical.

¹⁶What is not visible is the dynamics that leads to a non-zero meson expectation value.

¹⁷In fact it is a trivial rotation of the way in which the configuration is usually presented in the literature.

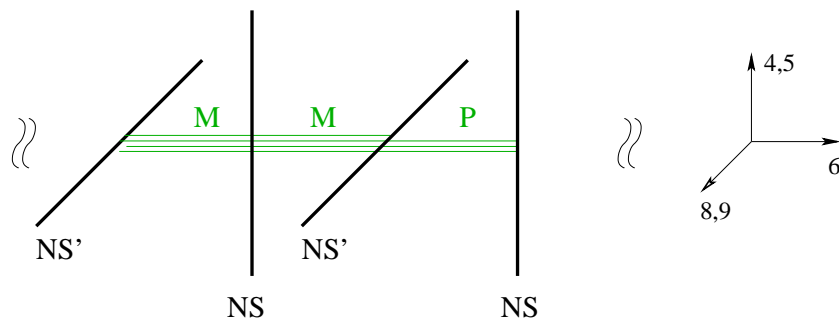

Figure 16: Type IIA brane configuration dual to the $(P, M, M, 0)$ quiver.

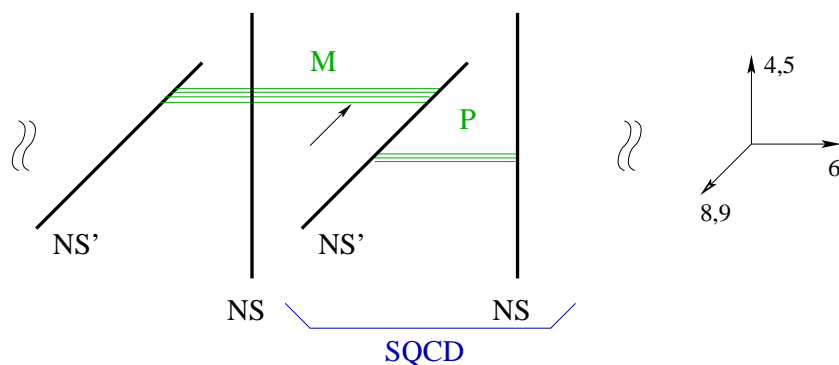

Figure 17: Type IIA configuration dual in the mesonic branch.

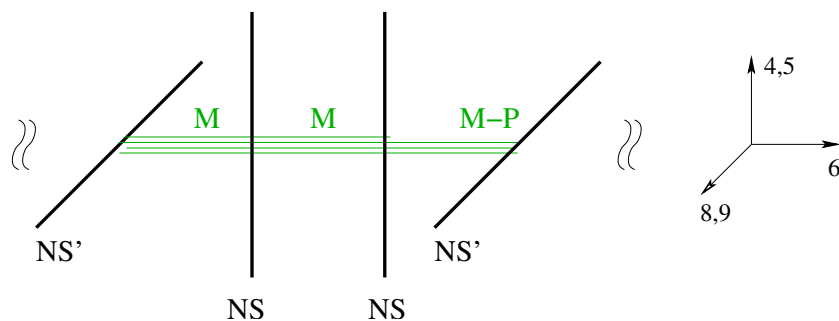

Figure 18: Type IIA configuration after Seiberg dualizing the $SU(P)$ node.

The meta-stable vacuum is identified in the free magnetic theory obtained by performing a Seiberg duality transformation on the $SU(P)$ gauge group. Let us perform that duality, setting the meson vevs to zero for the time being. Seiberg duality corresponds to a continuation through infinite coupling that is mapped in the IIA language to moving the NS' across the NS. The resulting configuration is shown in figure 18.

Let us now reinsert the meson vevs. Figure 19 shows what happens when $M - P$ meson eigenvalues are non-zero. In a T-dual version of the discussion in §5.3, the system consisting of the two NS'-branes and the $M - P$ D4-branes preserves $\mathcal{N} = 2$ SUSY. Giving non-zero vevs to the lowest P components corresponds to moving the P remaining D4-branes in the

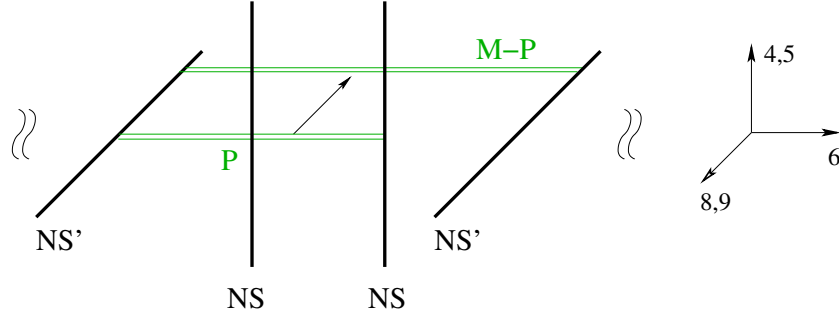

Figure 19: Type IIA configuration when the rank of the meson vevs is equal to $M - P$. Turning on additional non-zero vevs break supersymmetry.

89 directions. It is clear that doing this breaks supersymmetry.

Trying to extend these brane configurations to generic points in the MQCD parameter space will probably face the same obstacles studied in [24]. These subtleties are not present in our gauge/gravity setup.

References

- [1] E. Witten, *Dynamical breaking of supersymmetry*, *Nucl. Phys.* **B 188** (1981) 513.
- [2] I. Affleck, M. Dine and N. Seiberg, *Dynamical supersymmetry breaking in four-dimensions and its phenomenological implications*, *Nucl. Phys.* **B 256** (1985) 557.
- [3] S. Dimopoulos, G.R. Dvali, R. Rattazzi and G.F. Giudice, *Dynamical soft terms with unbroken supersymmetry*, *Nucl. Phys.* **B 510** (1998) 12 [[hep-ph/9705307](#)];
S. Dimopoulos, G.R. Dvali and R. Rattazzi, *Dynamical inflation and unification scale on quantum moduli spaces*, *Phys. Lett.* **B 410** (1997) 119 [[hep-ph/9705348](#)].
- [4] M. Dine, W. Fischler and M. Srednicki, *Supersymmetric technicolor*, *Nucl. Phys.* **B 189** (1981) 575;
S. Dimopoulos and S. Raby, *Supercolor*, *Nucl. Phys.* **B 192** (1981) 353;
M. Dine and W. Fischler, *A phenomenological model of particle physics based on supersymmetry*, *Phys. Lett.* **B 110** (1982) 227;
C.R. Nappi and B.A. Ovrut, *Supersymmetric extension of the $SU(3) \times SU(2) \times U(1)$ model*, *Phys. Lett.* **B 113** (1982) 175;
L. Alvarez-Gaumé, M. Claudson and M.B. Wise, *Low-energy supersymmetry*, *Nucl. Phys.* **B 207** (1982) 96;
S. Dimopoulos and S. Raby, *Geometric hierarchy*, *Nucl. Phys.* **B 219** (1983) 479.
- [5] H. Murayama, *A model of direct gauge mediation*, *Phys. Rev. Lett.* **79** (1997) 18 [[hep-ph/9705271](#)];
K.I. Izawa, Y. Nomura, K. Tobe and T. Yanagida, *Direct-transmission models of dynamical supersymmetry breaking*, *Phys. Rev.* **D 56** (1997) 2886 [[hep-ph/9705228](#)];
M.A. Luty, *Simple gauge-mediated models with local minima*, *Phys. Lett.* **B 414** (1997) 71 [[hep-ph/9706554](#)];
S. Dimopoulos, G.R. Dvali and R. Rattazzi, *A simple complete model of gauge-mediated SUSY-breaking and dynamical relaxation mechanism for solving the μ problem*, *Phys. Lett.* **B 413** (1997) 336 [[hep-ph/9707537](#)];

- Y. Shirman, *New models of gauge mediated dynamical supersymmetry breaking*, *Phys. Lett. B* **417** (1998) 281 [[hep-ph/9709383](#)];
- K. Agashe, *An improved model of direct gauge mediation*, *Phys. Lett. B* **435** (1998) 83 [[hep-ph/9804450](#)].
- [6] M. Dine, J.L. Feng and E. Silverstein, *Retrofitting O'Raifeartaigh models with dynamical scales*, *Phys. Rev. D* **74** (2006) 095012 [[hep-th/0608159](#)].
- [7] E. Silverstein, *(A)dS backgrounds from asymmetric orientifolds*, [hep-th/0106209](#).
- [8] S. Kachru, R. Kallosh, A. Linde and S.P. Trivedi, *de Sitter vacua in string theory*, *Phys. Rev. D* **68** (2003) 046005 [[hep-th/0301240](#)].
- [9] R. Bousso and J. Polchinski, *Quantization of four-form fluxes and dynamical neutralization of the cosmological constant*, *JHEP* **06** (2000) 006 [[hep-th/0004134](#)].
- [10] N. Seiberg, *Electric - magnetic duality in supersymmetric nonabelian gauge theories*, *Nucl. Phys. B* **435** (1995) 129 [[hep-th/9411149](#)].
- [11] J.M. Maldacena, *The large- N limit of superconformal field theories and supergravity*, *Adv. Theor. Math. Phys.* **2** (1998) 231 [*Int. J. Theor. Phys.* **33** (1999) 1113] [[hep-th/9711200](#)].
- [12] J.M. Maldacena and H. Nastase, *The supergravity dual of a theory with dynamical supersymmetry breaking*, *JHEP* **09** (2001) 024 [[hep-th/0105049](#)].
- [13] S. Kachru, J. Pearson and H.L. Verlinde, *Brane/flux annihilation and the string dual of a non-supersymmetric field theory*, *JHEP* **06** (2002) 021 [[hep-th/0112197](#)].
- [14] D. Berenstein, C.P. Herzog, P. Ouyang and S. Pinansky, *Supersymmetry breaking from a Calabi-Yau singularity*, *JHEP* **09** (2005) 084 [[hep-th/0505029](#)].
- [15] S. Franco, A. Hanany, F. Saad and A.M. Uranga, *Fractional branes and dynamical supersymmetry breaking*, *JHEP* **01** (2006) 011 [[hep-th/0505040](#)].
- [16] M. Bertolini, F. Bigazzi and A.L. Cotrone, *Supersymmetry breaking at the end of a cascade of Seiberg dualities*, *Phys. Rev. D* **72** (2005) 061902 [[hep-th/0505055](#)].
- [17] E. Witten, *Supersymmetric index of three-dimensional gauge theory*, [hep-th/9903005](#).
- [18] K. Intriligator and N. Seiberg, *The runaway quiver*, *JHEP* **02** (2006) 031 [[hep-th/0512347](#)].
- [19] A. Brini and D. Forcella, *Comments on the non-conformal gauge theories dual to $Y(p,q)$ manifolds*, *JHEP* **06** (2006) 050 [[hep-th/0603245](#)].
- [20] B. Florea, S. Kachru, J. McGreevy and N. Saulina, *Stringy instantons and quiver gauge theories*, [hep-th/0610003](#).
- [21] R. Argurio, M. Bertolini, C. Closset and S. Cremonesi, *On stable non-supersymmetric vacua at the bottom of cascading theories*, *JHEP* **09** (2006) 030 [[hep-th/0606175](#)].
- [22] S. Franco and A. M. Uranga, *Dynamical SUSY breaking at meta-stable minima from D-branes at obstructed geometries*, *JHEP* **06** (2006) 031 [[hep-th/0604136](#)].
- [23] I.R. Klebanov and M. Strassler, *Supergravity and a confining gauge theory: duality cascades and χ SB-resolution of naked singularities*, *JHEP* **08** (2000) 052 [[hep-th/0007191](#)].
- [24] I. Bena, E. Gorbatov, S. Hellerman, N. Seiberg and D. Shih, *A note on (meta)stable brane configurations in MQCD*, *JHEP* **11** (2006) 088 [[hep-th/0608157](#)].
- [25] S. Kachru et al., *Towards inflation in string theory*, *JCAP* **10** (2003) 013 [[hep-th/0308055](#)].

- [26] O. DeWolfe, S. Kachru and H.L. Verlinde, *The giant inflaton*, *JHEP* **05** (2004) 017 [[hep-th/0403123](#)].
- [27] K. Intriligator, N. Seiberg and D. Shih, *Dynamical SUSY breaking in meta-stable vacua*, *JHEP* **04** (2006) 021 [[hep-th/0602239](#)].
- [28] H. Ooguri and Y. Ookouchi, *Landscape of supersymmetry breaking vacua in geometrically realized gauge theories*, *Nucl. Phys.* **B 755** (2006) 239 [[hep-th/0606061](#)].
- [29] T. Banks, *Remodeling the pentagon after the events of 2/23/06*, [hep-ph/0606313](#).
- [30] S. Förste, *Gauging flavour in meta-stable SUSY breaking models*, [hep-th/0608036](#).
- [31] A. Amariti, L. Girardello and A. Mariotti, *Non-supersymmetric meta-stable vacua in $SU(N)$ SQCD with adjoint matter*, [hep-th/0608063](#).
- [32] N. Seiberg, *Exact results on the space of vacua of four-dimensional SUSY gauge theories*, *Phys. Rev.* **D 49** (1994) 6857 [[hep-th/9402044](#)].
- [33] A.M. Uranga, *Brane configurations for branes at conifolds*, *JHEP* **01** (1999) 022 [[hep-th/9811004](#)].
- [34] C.V. Johnson, A.W. Peet and J. Polchinski, *Gauge theory and the excision of repulson singularities*, *Phys. Rev.* **D 61** (2000) 086001 [[hep-th/9911161](#)].
- [35] I. Affleck, M. Dine and N. Seiberg, *Dynamical supersymmetry breaking in supersymmetric QCD*, *Nucl. Phys.* **B 241** (1984) 493.
- [36] I.R. Klebanov and A.A. Tseytlin, *Gravity duals of supersymmetric $SU(N) \times SU(n+m)$ gauge theories*, *Nucl. Phys.* **B 578** (2000) 123 [[hep-th/0002159](#)].
- [37] M.J. Strassler, *The duality cascade*, [hep-th/0505153](#).
- [38] S. Franco, Y.-H. He, C. Herzog and J. Walcher, *Chaotic duality in string theory*, *Phys. Rev.* **D 70** (2004) 046006 [[hep-th/0402120](#)].
- [39] C.P. Herzog, Q.J. Ejaz and I.R. Klebanov, *Cascading RG flows from new Sasaki-Einstein manifolds*, *JHEP* **02** (2005) 009 [[hep-th/0412193](#)].
- [40] A. Dymarsky, I.R. Klebanov and N. Seiberg, *On the moduli space of the cascading $SU(n+m) \times SU(P)$ gauge theory*, *JHEP* **01** (2006) 155 [[hep-th/0511254](#)].
- [41] S.B. Giddings, S. Kachru and J. Polchinski, *Hierarchies from fluxes in string compactifications*, *Phys. Rev.* **D 66** (2002) 106006 [[hep-th/0105097](#)].
- [42] S.S. Gubser, C.P. Herzog and I.R. Klebanov, *Symmetry breaking and axionic strings in the warped deformed conifold*, *JHEP* **09** (2004) 036 [[hep-th/0405282](#)].
- [43] R. Gopakumar and C. Vafa, *On the gauge theory/geometry correspondence*, *Adv. Theor. Math. Phys.* **3** (1999) 1415 [[hep-th/9811131](#)].
- [44] C. Vafa, *Superstrings and topological strings at large- N* , *J. Math. Phys.* **42** (2001) 2798 [[hep-th/0008142](#)].
- [45] S. Gukov, C. Vafa and E. Witten, *CFT's from Calabi-Yau four-folds*, *Nucl. Phys.* **B 584** (2000) 69 [[hep-th/9906070](#)].
- [46] T.R. Taylor, G. Veneziano and S. Yankielowicz, *Supersymmetric QCD and its massless limit: an effective Lagrangian analysis*, *Nucl. Phys.* **B 218** (1983) 493.

- [47] D. Berenstein, *D-brane realizations of runaway behavior and moduli stabilization*, hep-th/0303230.
- [48] E. Imeroni and A. Lerda, *Non-perturbative gauge superpotentials from supergravity*, *JHEP* **12** (2003) 051 [hep-th/0310157].
- [49] I.R. Klebanov and E. Witten, *Superconformal field theory on threebranes at a Calabi-Yau singularity*, *Nucl. Phys. B* **536** (1998) 199 [hep-th/9807080].
- [50] R.C. Myers, *Dielectric-branes*, *JHEP* **12** (1999) 022 [hep-th/9910053].
- [51] J. Polchinski, *String theory. Vol 2: Superstring theory and beyond*, Cambridge University Press (1998), pp. 169-170.
- [52] M. Grana and J. Polchinski, *Supersymmetric three-form flux perturbations on AdS₅*, *Phys. Rev. D* **63** (2001) 026001 [hep-th/0009211].
- [53] M. Bertolini et al., *Fractional D-branes and their gauge duals*, *JHEP* **02** (2001) 014 [hep-th/0011077].
- [54] R. Argurio, G. Ferretti and C. Petersson, *Massless fermionic bound states and the gauge/gravity correspondence*, *JHEP* **03** (2006) 043 [hep-th/0601180].
- [55] W. Fulton, *Introduction to toric varieties*, Princeton University Press, 1993.
- [56] P.S. Aspinwall, B.R. Greene and D.R. Morrison, *Calabi-Yau moduli space, mirror manifolds and spacetime topology change in string theory*, *Nucl. Phys. B* **416** (1994) 414 [hep-th/9309097].
- [57] D.R. Morrison and M. Ronen Plesser, *Summing the instantons: quantum cohomology and mirror symmetry in toric varieties*, *Nucl. Phys. B* **440** (1995) 279 [hep-th/9412236].
- [58] N.C. Leung and C. Vafa, *Branes and toric geometry*, *Adv. Theor. Math. Phys.* **2** (1998) 91 [hep-th/9711013].
- [59] S. Franco and A. Hanany, *Geometric dualities in 4D field theories and their 5D interpretation*, *JHEP* **04** (2003) 043 [hep-th/0207006].
- [60] E. Witten, *Phases of $N = 2$ theories in two dimensions*, *Nucl. Phys. B* **403** (1993) 159 [hep-th/9301042].
- [61] O. Aharony and A. Hanany, *Branes, superpotentials and superconformal fixed points*, *Nucl. Phys. B* **504** (1997) 239 [hep-th/9704170].
- [62] O. Aharony, A. Hanany and B. Kol, *Webs of (p, q) 5-branes, five dimensional field theories and grid diagrams*, *JHEP* **01** (1998) 002 [hep-th/9710116].
- [63] H. Ooguri and Y. Ookouchi, *Meta-stable supersymmetry breaking vacua on intersecting branes*, *Phys. Lett. B* **641** (2006) 323 [hep-th/0607183].
- [64] S. Franco, I. Garcia-Etxebarria and A.M. Uranga, *Non-supersymmetric meta-stable vacua from brane configurations*, hep-th/0607218.
- [65] C. Ahn, *Brane configurations for nonsupersymmetric meta-stable vacua in SQCD with adjoint matter*, hep-th/0608160.